



# URZ-Sicherungen

Sicherungseinsätze zylindrische Bauform

# URZ Fuses

Fuse-links cylindrical

Technische Daten nach Baureihen /  
Technical Data Types of Fuses

Technische Daten Sicherungs-Unterteile /  
Technical Data Fuse Bases

**250 V**

**Ø 5 x 20 mm**

 **usE180276**

Verpackungseinheit / Packing unit: 100 Stück / 100 pieces

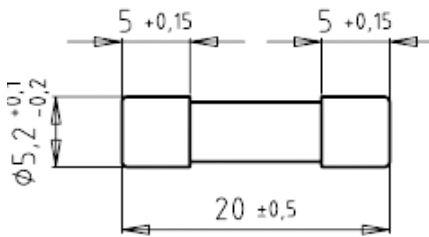

Charakteristik / Class <b>FF</b>	<b>IEC 60 269-4</b> <b>VDE 0636-4</b> <b>UL 248-13</b>
-------------------------------------	--

Bemessungs- spannung Rated Voltage	Artikel Nr. Article No	Größe Size	Bemessungsstrom Rated Current
V			A
400/250/125	70 007 40	5 x 20	0,1-16

Bemessungsausschaltvermögen / Rated breaking capacity **10 kA 400 V**  
**200 kA 250 V**  
**10 kA 125 V**

Bemessungsstrom Rated Current	Artikel Nr. Article No.	Gewicht Weight	Bemessungs- spannung Rated Voltage	Spannungs- abfall Max. Voltage drop	Schmelzintegral Pre-Arcing- I <sup>2</sup> t-Value	Ausschalt- integral Total I <sup>2</sup> t-Value	Leistungs- abgabe Power Loss
A		kg / l	V	mV	A <sup>2</sup> s	A <sup>2</sup> s	W
0,100	70 007 40.0,1	0,001	400	4.000	0,0016	0,0035	0,4
0,125	70 007 40.0,125	0,001	400	3.500	0,0024	0,0053	0,5
0,160	70 007 40.0,16	0,001	400	1.300	0,004	0,009	0,3
0,200	70 007 40.0,2	0,001	400	600	0,01	0,022	0,2
0,250	70 007 40.0,25	0,001	400	550	0,02	0,044	0,2
0,315	70 007 40.0,315	0,001	400	500	0,04	0,09	0,2
0,400	70 007 40.0,4	0,001	400	500	0,07	0,15	0,2
0,500	70 007 40.0,5	0,001	400	550	0,07	0,15	0,3
0,630	70 007 40.0,63	0,001	400	600	0,15	0,34	0,4
0,800	70 007 40.0,8	0,001	400	600	0,32	0,7	0,5
1	70 007 40.1	0,001	400	600	0,32	0,7	0,6
1,25	70 007 40.1,5	0,001	400	400	0,20	0,44	0,5
1,6	70 007 40.1,6	0,001	400	400	0,31	0,68	0,7
2	70 007 40.2	0,001	400	400	0,64	1,4	0,8
2,5	70 007 40.2,5	0,001	400	400	0,88	1,9	1,0
3,15	70 007 40.3,15	0,001	400	400	1,6	3,5	1,3
4	70 007 40.4	0,001	400	350	3,2	7,0	1,4
6,3	70 007 40.6,3*	0,001	250	300	1,6	4,8	2,8
8	70 007 40.8*	0,001	250	300	4,5	14	3
10	70 007 40.10*	0,001	250	300	8,8	26	3,4
12,5	70 007 40.12,5*	0,001	250	200	15	44	4
16	70 007 40.16	0,001	125	130	46	100	3,8



Applikationskoeffizienten / Application coefficients (Weiterführende Informationen siehe Seite 13 / for more information see page 13)

a	A2	B1 max.	B2	CF3
130	0,8	1,25	0,8	0,8

250 V

Ø 5 x 20 mm

cULusE180276

**Zeit/Strom-  
Kennlinien**  
Time-current  
characteristics

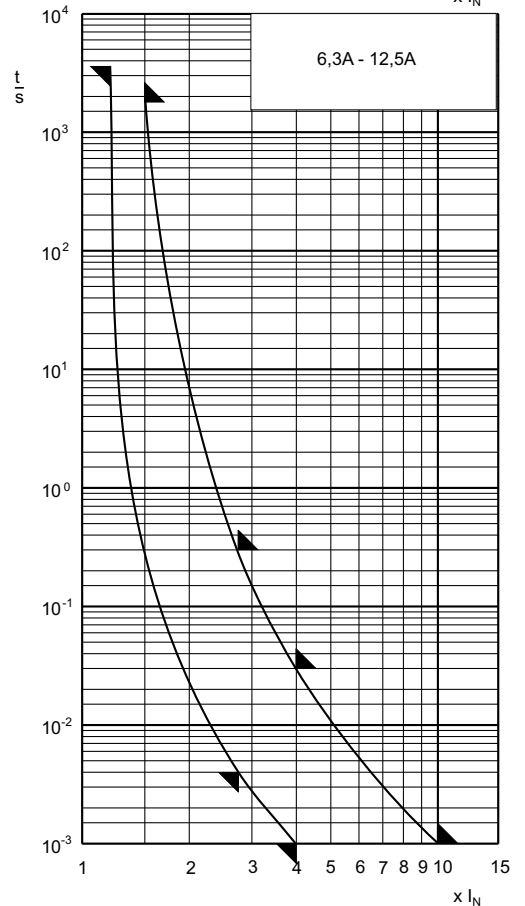
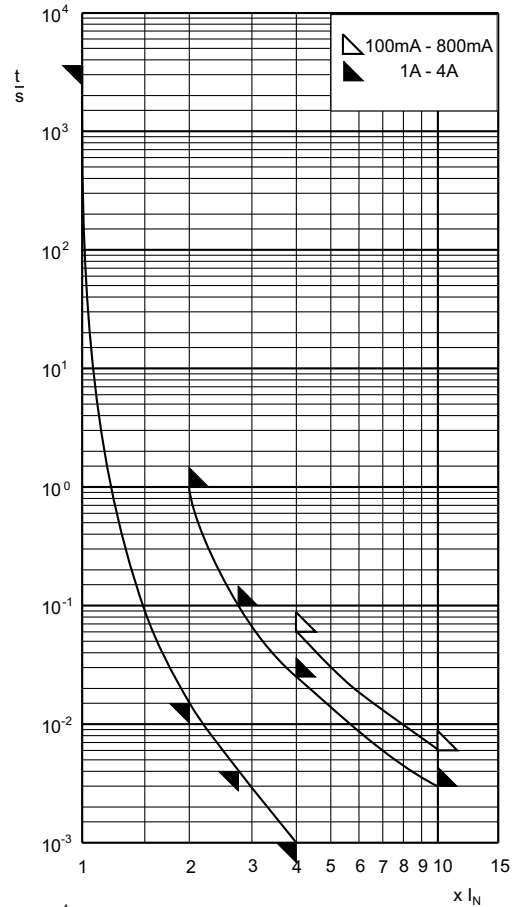

**400 V**

**Ø 6,35 x 32 mm**

 usE180276

Verpackungseinheit / Packing unit: 100 Stück / 100 pieces

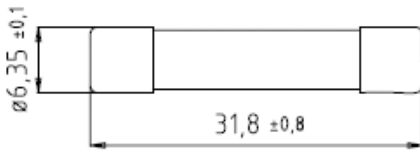

Betriebsklasse / Class  
**gRL (gS)**

**IEC 60 269-4**  
**VDE 0636-4**

Bemessungs- spannung Rated Voltage	Artikel Nr. Article No	Größe Size	Bemessungsstrom Rated Current
V			A
400	70 065 84	6,35 x 32 mm	6,3-20

Bemessungsausschaltvermögen / Rated breaking capacity **120 kA**

Bemessungsstrom Rated Current	Artikel Nr. Article No.	Gewicht Weight	Bemessungs- spannung Rated Voltage	Spannungs- abfall Max. Voltage drop	Schmelzintegral Pre-Arcing- I <sup>2</sup> t-Value	Ausschalt- integral Total I <sup>2</sup> t-Value	Leistungs- abgabe Power Loss
A		kg / 1	V	mV	A <sup>2</sup> s	A <sup>2</sup> s	W
6,3	70 065 84.6,3	0,003	400	190	1,8	11	1,2
8	70 065 84.8	0,003	400	190	3,0	18	1,5
10	70 065 84.10	0,003	400	180	5,1	31	1,8
12,5	70 065 84.12,5	0,003	400	150	12	69	1,9
16	70 065 84.16	0,003	400	150	20	120	2,3
20	70 065 84.20	0,003	400	160	35	210	3,2

Applikationskoeffizienten / Application coefficients (Weiterführende Informationen siehe Seite 13 / for more information see page 13)

a	A2	B1 max.	B2	Cf3
130	0,8	1,25	0,8	0,8

400 V

Ø 6,35 x 32 mm

cULusE180276

Zeit/Strom-  
Kennlinien  
Time-current  
characteristics

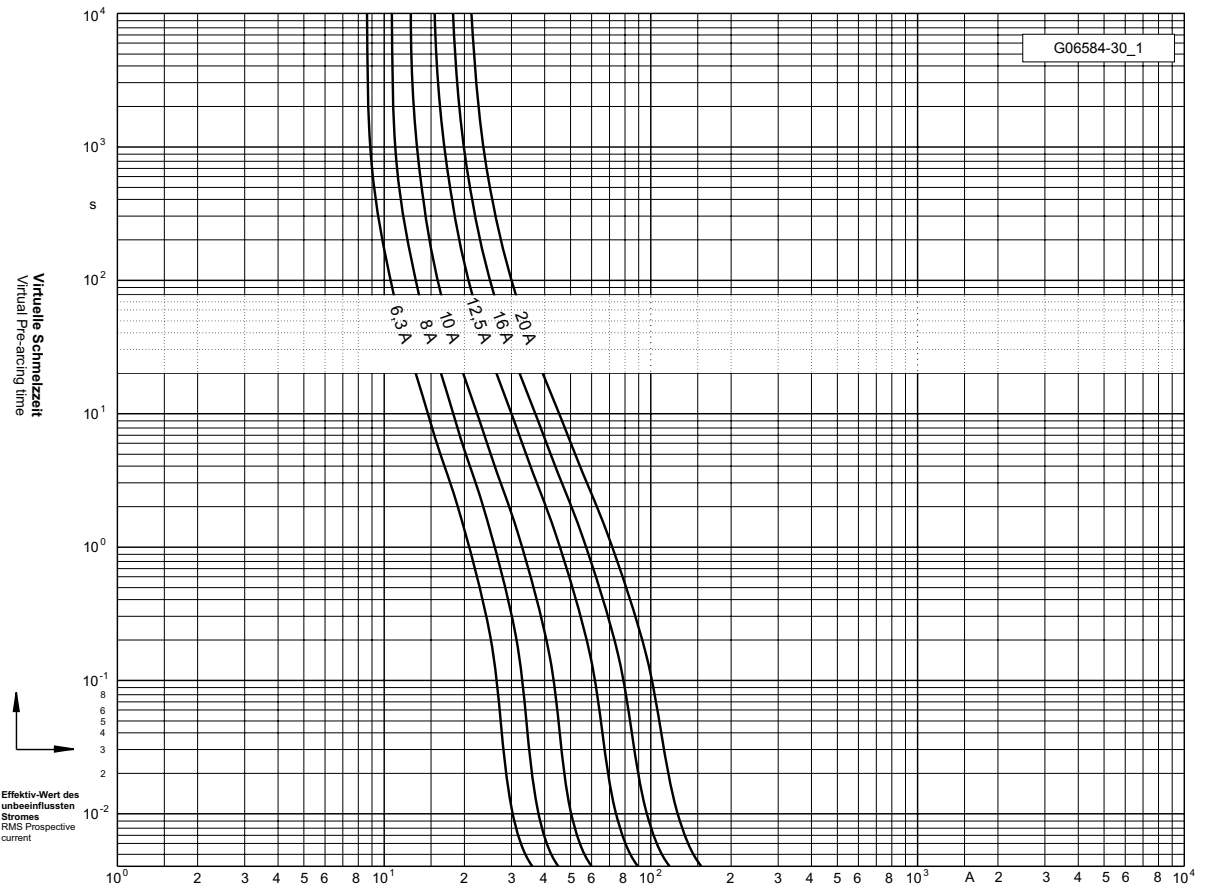

Durchlass-Strom  
Cut-off current

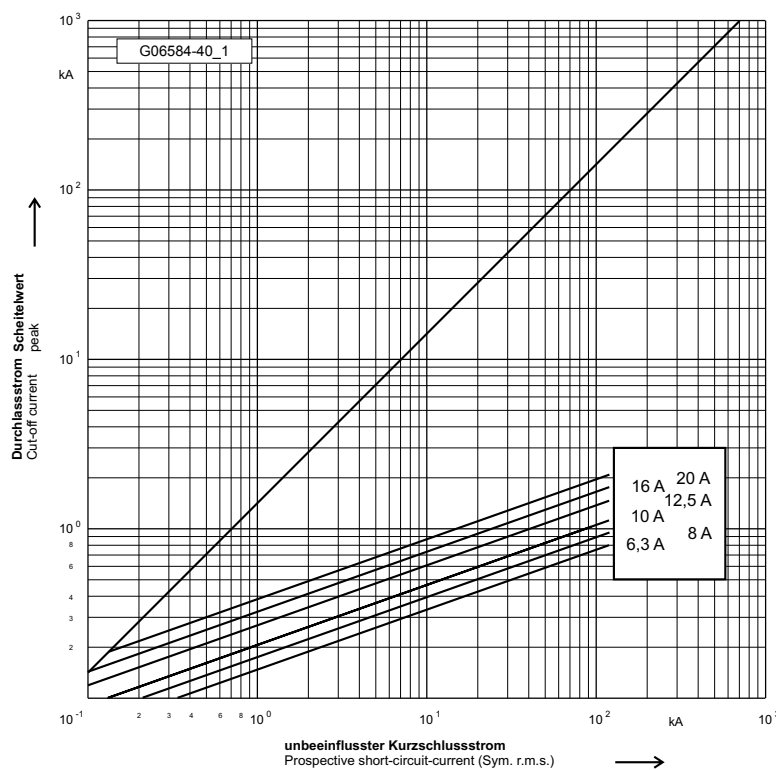

**500-700V Ø 6,35 x 32 mm**

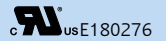

Verpackungseinheit / Packing unit: 100 Stück / 100 pieces

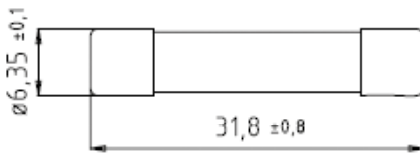

Charakteristik / Class <b>FF</b>	<b>IEC 60 269-4</b> <b>VDE 0636-4</b> <b>UL 248-13</b>
-------------------------------------	--

Bemessungs- spannung Rated Voltage	Artikel Nr. Article No	Größe Size	Bemessungsstrom Rated Current
V			A
700	70 125 40	6,35 x 32	0,1-2
600			2,5-10
500			12,5-25

Bemessungsausschaltvermögen / Rated breaking capacity **50 kA**

Bemessungsstrom Rated Current	Artikel Nr. Article No.	Gewicht Weight	Bemessungs- spannung Rated Voltage	Spannungs- abfall Max. Voltage drop	Schmelzintegral Pre-Arcing- I <sup>2</sup> t-Value	Ausschaltinte- gral Total I <sup>2</sup> t-Value	Leistungs- abgabe Power Loss
A		kg / 1	V	mV	A <sup>2</sup> s	A <sup>2</sup> s	W
0,100	70 125 40.0,1	0,002	700	2.500	0.0009	0.003	0,3
0,125	70 125 40.0,125	0,002	700	2.200	0.0017	0.006	0,3
0,160	70 125 40.0,16	0,002	700	2.000	0.004	0.014	0,4
0,200	70 125 40.0,2	0,002	700	900	0.01	0,035	0,2
0,250	70 125 40.0,25	0,002	700	800	0.02	0,08	0,2
0,315	70 125 40.0,315	0,002	700	700	0.04	0,14	0,3
0,400	70 125 40.0,4	0,002	700	650	0.07	0,25	0,3
0,500	70 125 40.0,5	0,002	700	650	0.12	0,48	0,4
0,630	70 125 40.0,63	0,002	700	650	0.15	0,5	0,5
0,800	70 125 40.0,8	0,002	700	600	0.23	0,8	0,5
1	70 125 40.1	0,002	700	750	0.32	1,1	0,8
1,25	70 125 40.1,25	0,002	700	700	0.20	0,8	0,9
1,6	70 125 40.1,6	0,002	700	650	0.31	1,2	1,1
2	70 125 40.2	0,002	700	650	0.64	2,6	1,4
2,5	70 125 40.2,5	0,002	600	550	1.2	4	1,4
3,15	70 125 40.3,15	0,002	600	500	2.0	7	1,6
4	70 125 40.4	0,002	600	450	5.0	20	1,8
5	70 125 40.5	0,002	600	400	10	40	2,0
6,3	70 125 40.6,3	0,002	600	400	3.0	15	4
8	70 125 40.8	0,002	600	350	6.5	35	4,5
10	70 125 40.10	0,002	600	350	12	60	5
12,5	70 125 40.12,5	0,002	500	300	18	80	7
16	70 125 40.16	0,002	500	300	31	140	9
20	70 125 40.20	0,002	500	300	46	200	11
25	70 125 40.25	0,002	500	230	87	370	11

Applikationskoeffizienten / Application coefficients (Weiterführende Informationen siehe Seite 13 / for more information see page 13)

a	A2	B1 max.	B2	Cf3
130	0,8	1,25	0,8	0,8

**500-700V Ø 6,35 x 32 mm**

**RU**  
c usE180276

**Zeit/Strom-  
Kennlinien**  
Time-current  
characteristics

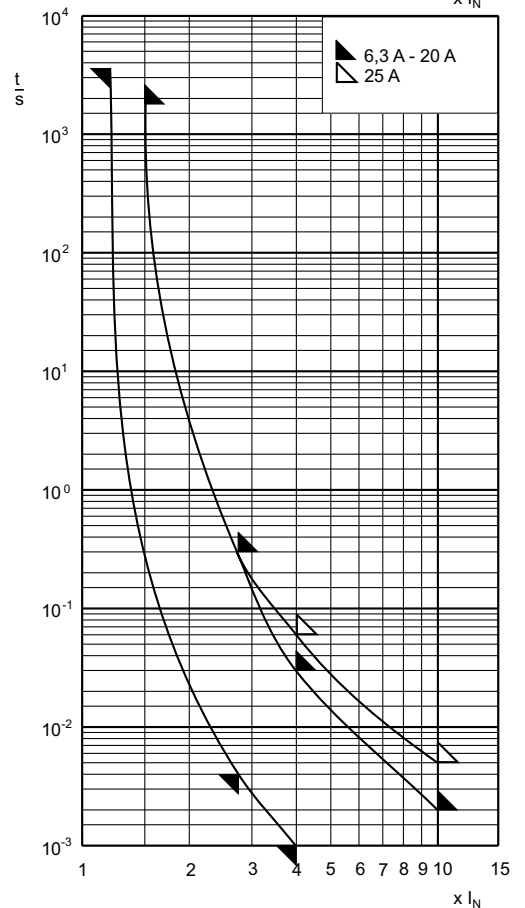
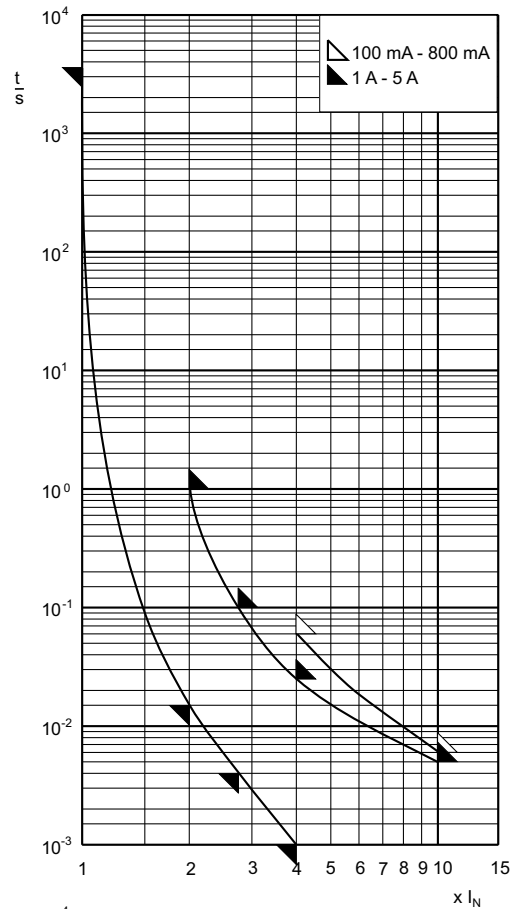

**600 V**

**Ø 10 x 38 mm**

 **usE180276**

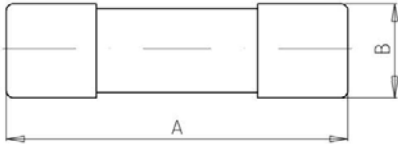

Verpackungseinheit / Packing unit: 10 Stück / 10 pieces

Betriebsklasse / Class  
**aR**

**IEC 60 269-4**  
**VDE 0636-40**  
**UL 248-13**

Bemessungs- spannung Rated Voltage	Artikel Nr. Article No	Größe Size	Bemessungsstrom Rated Current	Länge Length	
V			A	A	B
600	60 033 05	Ø 10 x 38 mm	1-30	38	10

Bemessungsausschaltvermögen / Rated breaking capacity **200 kA (AC 700 V)**

Bemessungsstrom Rated Current	Artikel Nr. Article No.	Gewicht Weight	Bemessungs- spannung Rated Voltage	Approbation Approvals	Schmelzintegral Pre-Arcing- I <sup>2</sup> t-Value	Ausschalt- integral Total I <sup>2</sup> t-Value @ AC 600 V	Leistungs- abgabe Power Loss
A		kg / 1	V	UL-Rec.	A <sup>2</sup> s	A <sup>2</sup> s	W
1	60 033 05.1	0,01	600	-	0,1	0,9	1,0
2	60 033 05.2	0,01	600	-	0,64	5,8	1,8
4	60 033 05.4	0,01	600	-	1,1	6	1,1
5	60 033 05.5	0,01	600	*	1,3	12	1,4
6	60 033 05.6	0,01	600	*	2,0	18	1,6
8	60 033 05.8	0,01	600	*	3	28	1,8
10	60 033 05.10	0,01	600	*	5,1	48	2,1
12	60 033 05.12	0,01	600	*	7,4	63	2,5
16	60 033 05.16	0,01	600	*	13	120	3,0
20	60 033 05.20	0,01	600	*	29	200	3,6
25	60 033 05.25	0,01	600	*	52	420	4,5
30	60 033 05.30	0,01	600	*	81	730	5,8

Applikationskoeffizienten / Application coefficients (Weiterführende Informationen siehe Seite 13 / for more information see page 13)

a	A2	B1 max.	B2	CF3
150	0,6	1,25	0,6	0,8



600 V

Ø 10 x 38 mm

**RU** usE180276

**Zeit/Strom-Kennlinien**  
Time-current characteristics

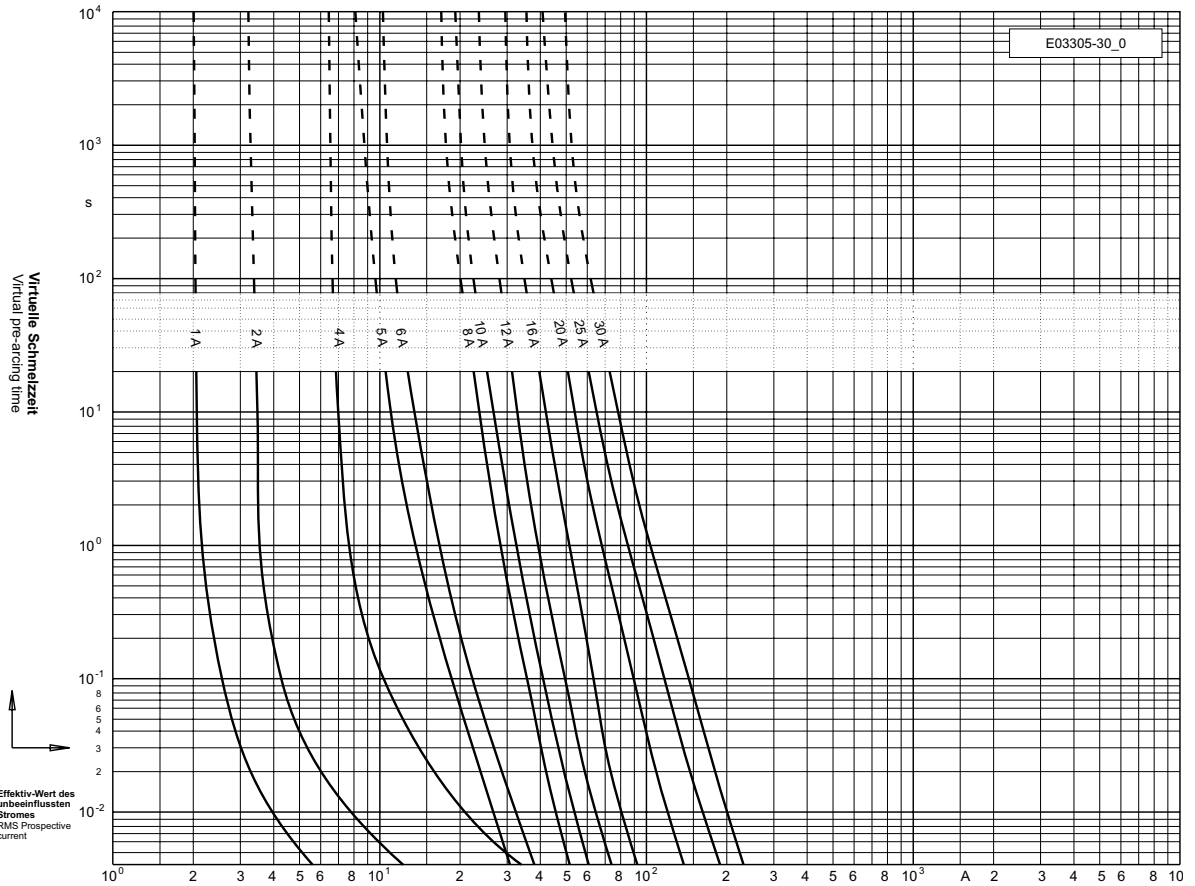

**Durchlass-Strom**  
Cut-off current

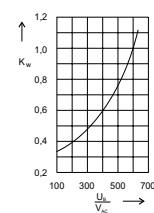
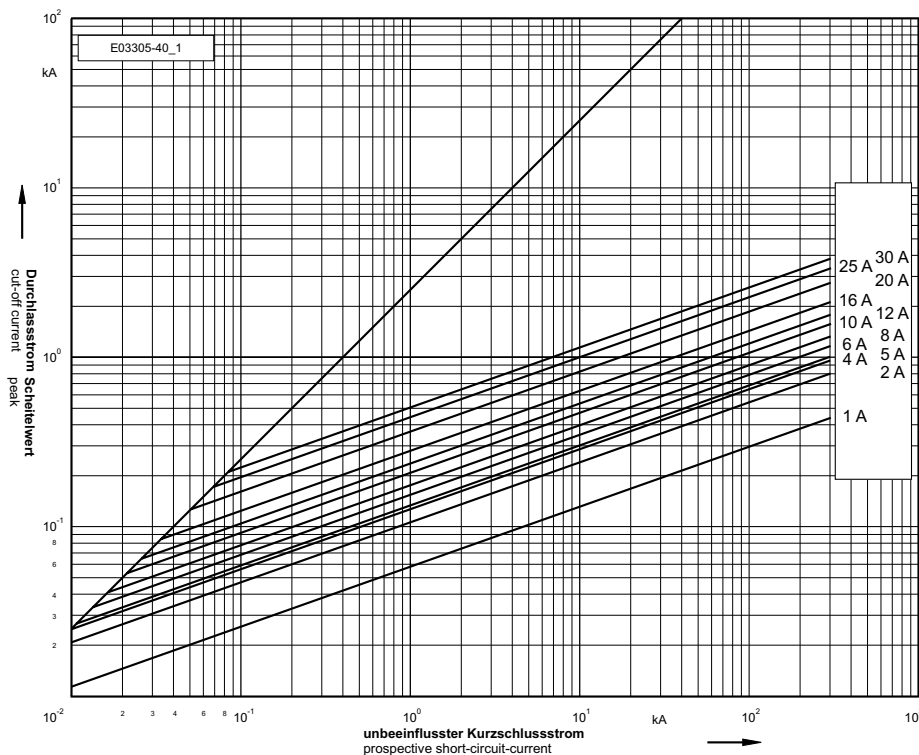

**Umrechnungsfaktor für den Ausschalt  $i^2t$ -Wert**  
Reduction factor for total  $i^2t$ -value

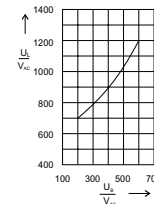

**Schaltspannungsdiagramm**  
Arc Voltage-Diagram

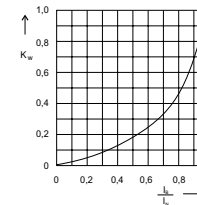

**Umrechnungsfaktor der Leistungsabgabe**  
Reduction factor for power loss

**600 V**

**Ø 10 x 38 mm**

 usE180276

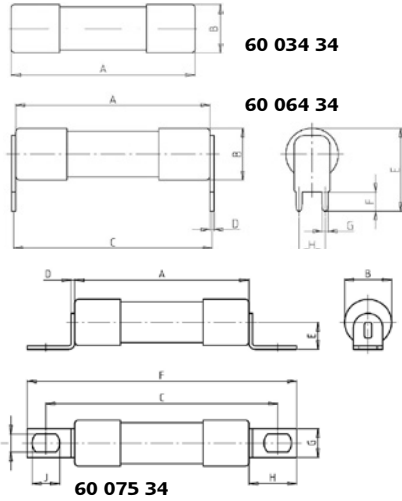

Verpackungseinheit / Packing unit: 10 Stück / 10 pieces

Betriebsklasse / Class <b>gRL (gS)</b>	<b>IEC 60 269-4</b> <b>VDE 0636-40</b> <b>UL 248-13</b>
---	---

Bemessungs- spannung Rated Voltage	Artikel Nr. Article No	Größe Size	Länge Length									
			A	B	C	D	E	F	G	H	I	J
V			mm	mm	mm	mm	mm	mm	mm	mm	mm	mm
600	60 034 34	10	38	10,3	-	-	-	-	-	-	-	-
	60 064 34	x	38	10,3	38,8	0,8	16,4	3,8	1,2	5,1	-	-
	60 075 34	38	38	10,3	50,6	0,8	6,0	58,8	6,4	10,4	4,0	6,0

Bemessungsausschaltvermögen / Rated breaking capacity **200 kA**

Bemessungs- strom Rated Current	Artikel Nr. Article No.			Gewicht Weight	Bemessungs- spannung Rated Voltage		Schmelz- integral	Ausschalt- integral	Leistungs- abgabe Power Loss
	A	mit Einlötpins for PCB mounting	mit Anschlußlaschen with bolted contacts		IEC 60269-4	UL 248-13.	Pre-Arcing- I <sup>2</sup> t-Value	Total I <sup>2</sup> t-Value	
						V	V	A <sup>2</sup> s	
6	60 034 34.6	60 064 34.6	60 075 34.6	0,01	500	600	2,5	20	1
8	60 034 34.8	60 064 34.8	60 075 34.8	0,01	500	600	3,3	36	1,3
10	60 034 34.10	60 064 34.10	60 075 34.10	0,01	500	600	5,1	41	1,1
12	60 034 34.12	60 064 34.12	60 075 34.12	0,01	500	600	8,7	69	1,9
16	60 034 34.16	60 064 34.16	60 075 34.16	0,01	500	600	17	130	2,4
20	60 034 34.20	60 064 34.20	60 075 34.20	0,01	500	600	29	240	3,5
25	60 034 34.25	60 064 34.25	60 075 34.25	0,01	500	600	66	530	3,8
30	60 034 34.30	60 064 34.30	60 075 34.30	0,01	500	600	120	950	4,3

Applikationskoeffizienten / Application coefficients (Weiterführende Informationen siehe Seite 13 / for more information see page 13)

a	A2	B1 max.	B2	CF3
150	1	1,25	0,5	0,8

600 V

Ø 10 x 38 mm

**RU** usE180276

**Zeit/Strom-Kennlinien**  
Time-current characteristics

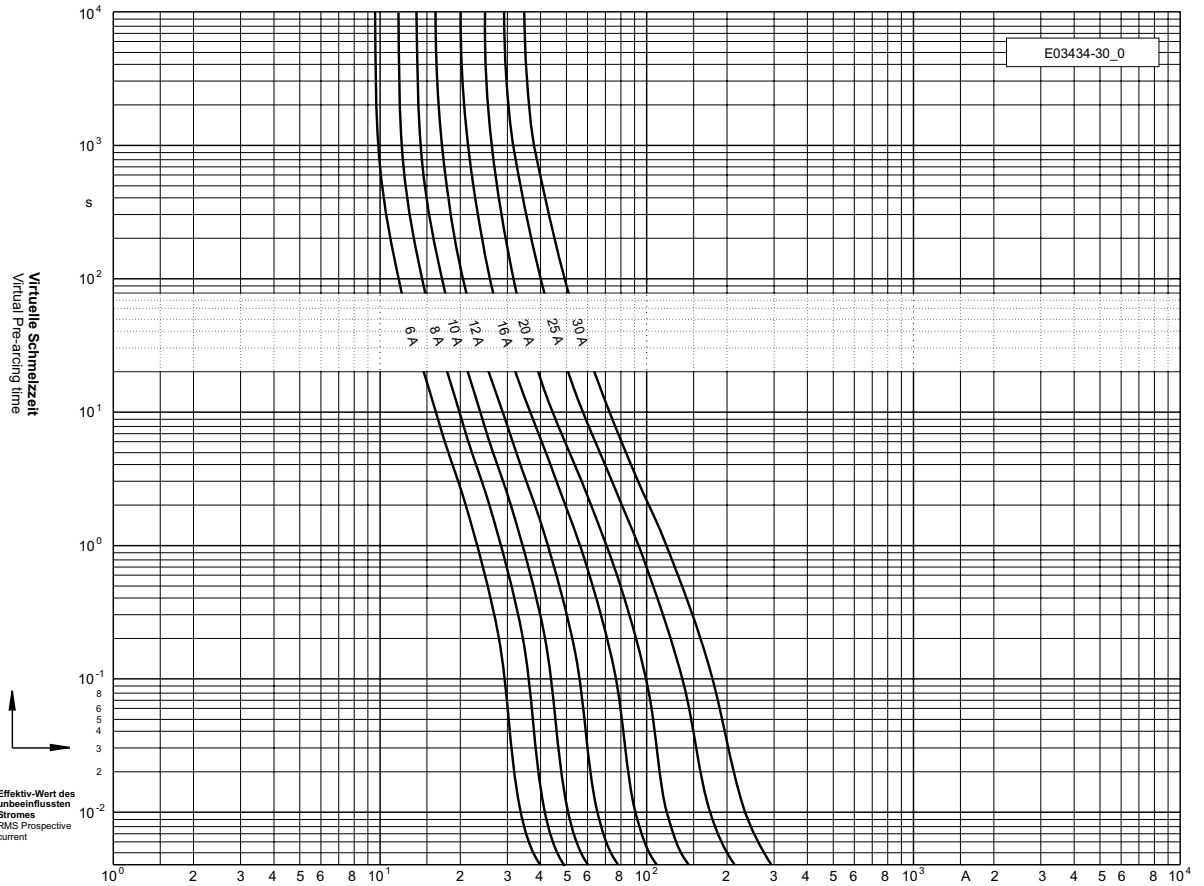

**Durchlass-Strom**  
Cut-off current

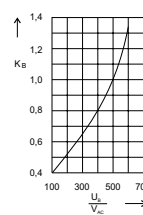
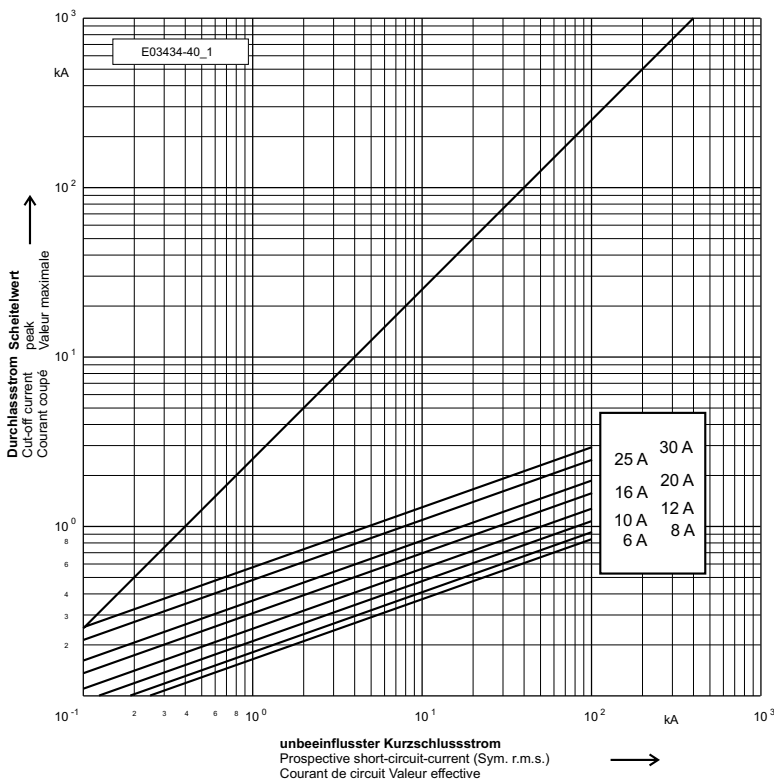

**Umrechnungsfaktor für den Ausschalt  $i^2t$ -Wert**  
Reduction factor for total  $i^2t$ -value

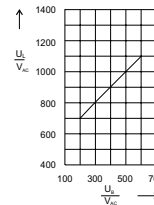

**Schaltspannungsdiagramm**  
Arc Voltage-Diagram

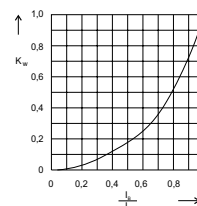

**Umrechnungsfaktor der Leistungsabgabe**  
Reduction factor for power Loss

**600 V**

**Ø 14 x 51 mm**



**50 058 06**

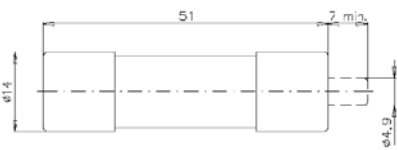

**50 059 06**

Verpackungseinheit / Packing unit: 10 Stück / 10 pieces

Betriebsklasse / Class <b>aR</b>	DIN EN 60269-4 IEC 60 269-4 VDE 0636-4	acc. UL 248-13
-------------------------------------	--	----------------

Bemessungs- spannung Rated Voltage	Artikel Nr. Article No	Größe Size	Bemessungsstrom Rated Current
V			A
500 / 600	50 058 06	Ø 14 x 51 mm	6-50
	50 059 06		

Bemessungsausschaltvermögen / Rated breaking capacity 100 kA

Bemessungsstrom Rated Current	Artikel Nr. Article No.		Gewicht Weight	Bemessungs- spannung Rated Voltage	Schmelz- integral Pre-Arcing- I <sup>2</sup> t-Value	Ausschalt- integral Total I <sup>2</sup> t-Value @ AC 500 V	Leistungs- abgabe Power Loss
	ohne Auslöser without striker	mit Auslöser with striker					
A			kg / l	V	A <sup>2</sup> s	A <sup>2</sup> s	W
6	50 058 06.6	50 059 06.6	0,02	600	3	18	1,3
8	50 058 06.8	50 059 06.8	0,02	600	5	27	1,7
10	50 058 06.10	50 059 06.10	0,02	600	8	48	2,4
12	50 058 06.12	50 059 06.12	0,02	600	12	93	2,5
16	50 058 06.16	50 059 06.16	0,02	600	21	150	4,0
20	50 058 06.20	50 059 06.20	0,02	600	32	250	4,6
25	50 058 06.25	50 059 06.25	0,02	600	63	400	6,4
32	50 058 06.32	50 059 06.32	0,02	600	104	680	8,2
40	50 058 06.40	50 059 06.40	0,02	600	140	1.200	9,1
50	50 058 06.50	50 059 06.50	0,02	500	230	1.600	12

Applikationskoeffizienten / Application coefficients (Weiterführende Informationen siehe Seite 13 / for more information see page 13)

a	A2	B1 max.	B2	CF3
170	0,6	1,25	0,6	0,8

600 V

Ø 14 x 51 mm

Zeit/Strom-  
Kennlinien  
Time-current  
characteristics

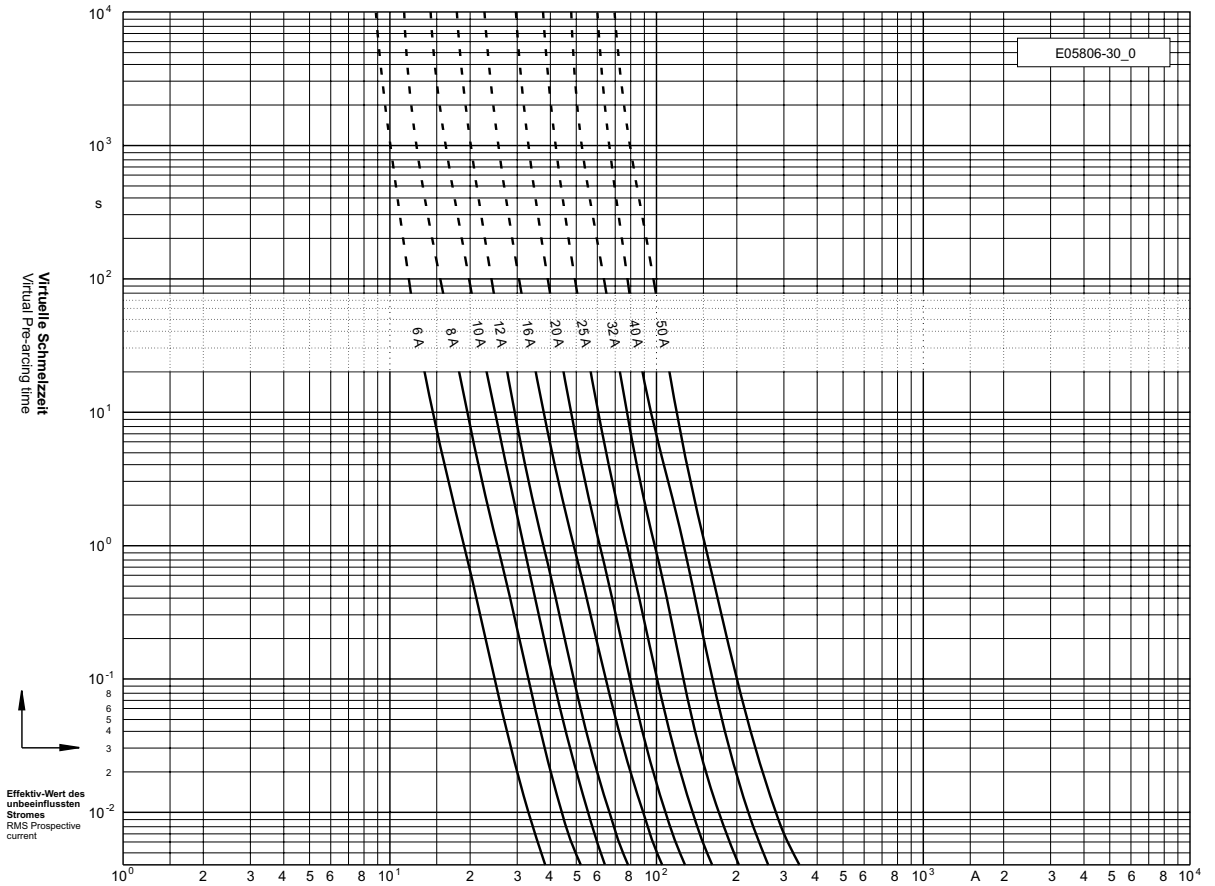

Durchlass-Strom  
Cut-off current

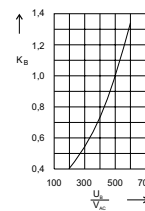
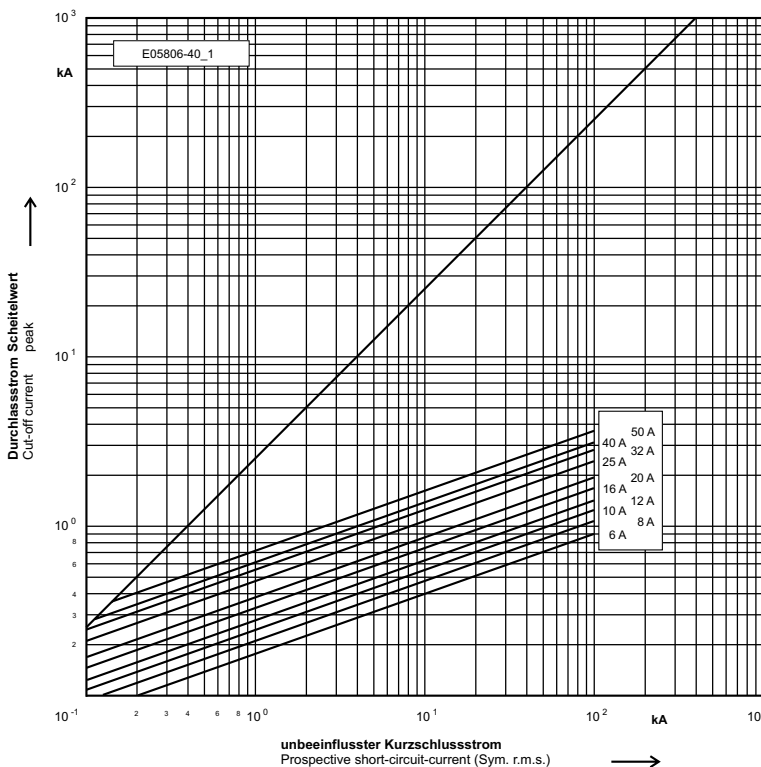

Umrechnungsfaktor  
für den  
Ausschalt  $i^2t$ -Wert  
Reduction factor  
for total  $i^2t$ -value

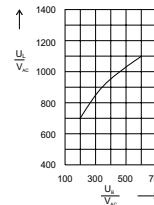

Schaltspannungs-  
diagramm  
Arc Voltage-Diagram

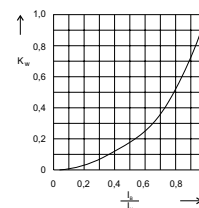

Umrechnungsfaktor  
der  
Leistungsabgabe  
Reduction factor  
for power Loss

**600 V**

**Ø 22 x 58 mm**

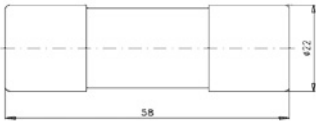

**50 060 06**

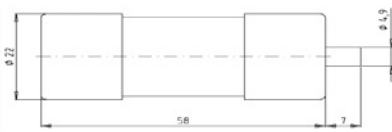

**50 061 06**

Verpackungseinheit / Packing unit: 10 Stück / 10 pieces

Betriebsklasse / Class <b>aR</b>	<b>DIN EN 60269-4</b> <b>IEC 60 269-4</b> <b>VDE 0636-4</b>	<b>acc. UL 248-13</b>
-------------------------------------	---	-----------------------

Bemessungs- spannung Rated Voltage	Artikel Nr. Article No	Größe Size	Bemessungsstrom Rated Current
V			A
600	50 060 06	Ø 22 x 58 mm	12-100
	50 061 06		

Bemessungsausschaltvermögen / Rated breaking capacity 100 kA

Bemessungsstrom Rated Current	Artikel Nr. Article No.		Gewicht Weight	Bemessungs- spannung Rated Voltage	Schmelzintegral Pre-Arcing- I <sup>2</sup> t-Value	Ausschalt- integral Total I <sup>2</sup> t-Value	Leistungs- abgabe Power Loss
	ohne Auslöser without striker	mit Auslöser with striker					
	A			kg / 1	V	A <sup>2</sup> s	@ AC 500 V A <sup>2</sup> s
12	50 060 06.12	50 061 06.12	0,06	600	16	93	2,1
16	50 060 06.16	50 061 06.16	0,06	600	21	170	3,6
20	50 060 06.20	50 061 06.20	0,06	600	32	250	4,6
25	50 060 06.25	50 061 06.25	0,06	600	63	400	5,3
32	50 060 06.32	50 061 06.32	0,06	600	104	730	8,2
40	50 060 06.40	50 061 06.40	0,06	600	140	1.000	8,6
50	50 060 06.50	50 061 06.50	0,06	600	230	1.800	11
63	50 060 06.63	50 061 06.63	0,06	600	350	2.600	15
80	50 060 06.80	50 061 06.80	0,06	600	740	5.000	18
100	50 060 06.100	50 061 06.100	0,06	600	1.400	10.000	20

Applikationskoeffizienten / Application coefficients (Weiterführende Informationen siehe Seite 13 / for more information see page 13)

a	A2	B1 max.	B2	CF3
170	0,6	1,25	0,6	0,8

600 V

Ø 22 x 58 mm

Zeit/Strom-  
Kennlinien  
Time-current  
characteristics

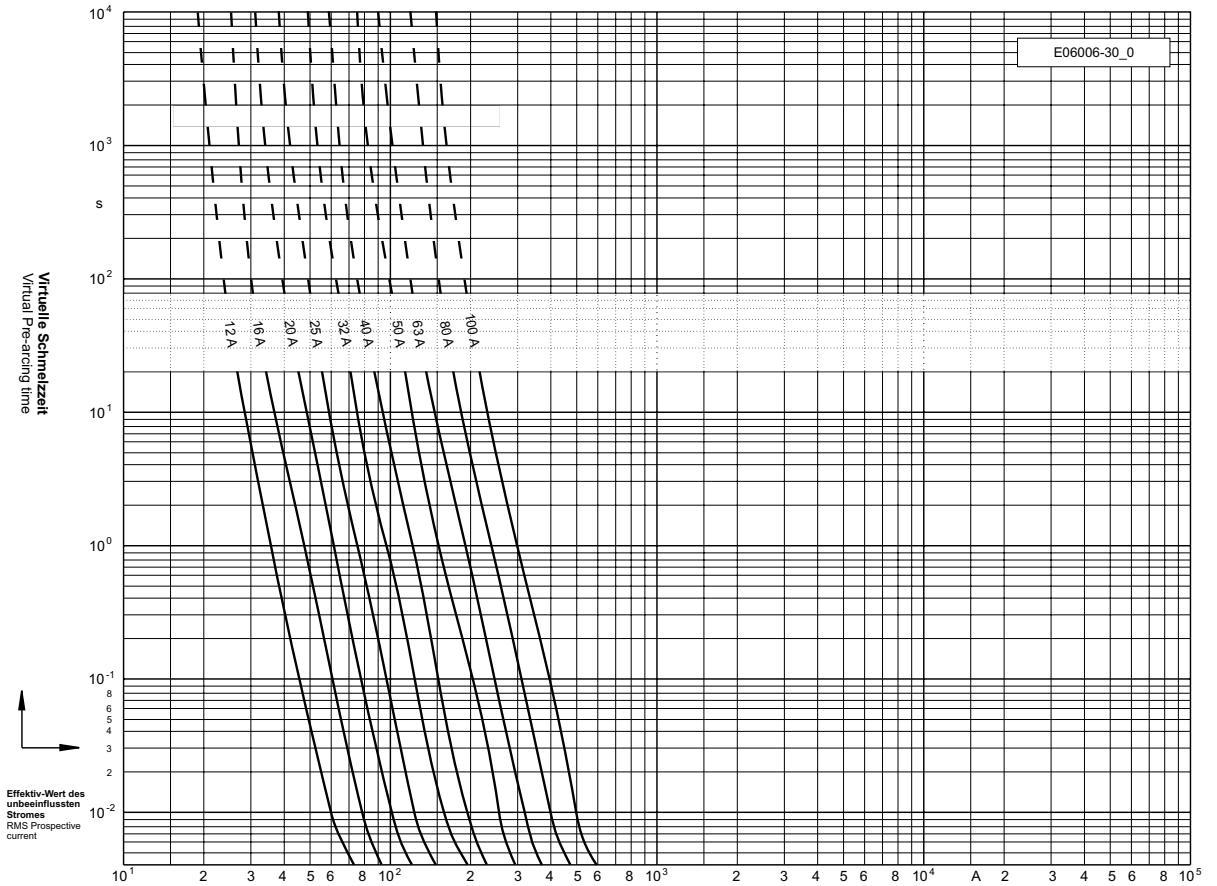

Durchlass-Strom  
Cut-off current

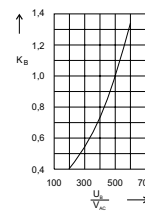
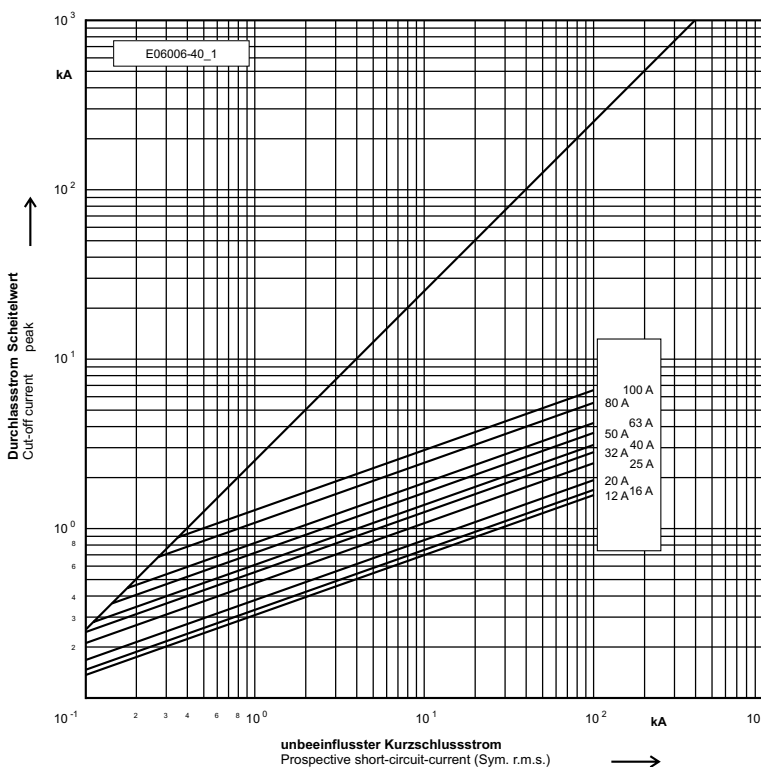

Umrechnungsfaktor  
für den  
Ausschalt  $i^2t$ -Wert  
Reduction factor  
for total  $i^2t$ -value

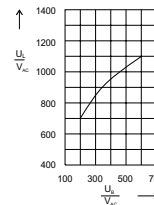

Schaltspannungs-  
diagramm  
Arc Voltage-Diagram

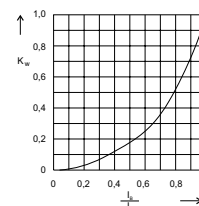

Umrechnungsfaktor  
der  
Leistungsabgabe  
Reduction factor  
for power Loss

**660 V**

**Ø 27 x 60 mm**

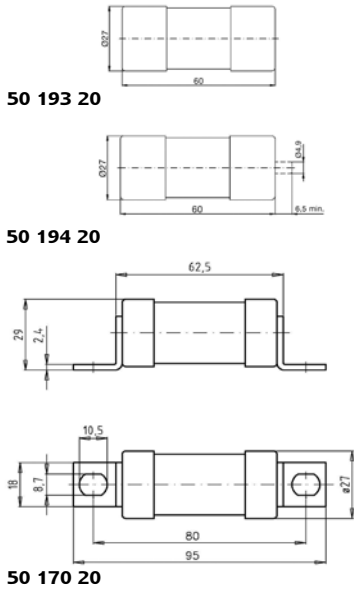

Verpackungseinheit / Packing unit: 10 Stück / 10 pieces

Betriebsklasse / Class <b>aR</b>	<b>IEC 60 269-4</b> <b>VDE 0636-4</b>
-------------------------------------	--

Bemessungs- spannung Rated Voltage	Artikel Nr. Article No	Größe Size	Bemessungsstrom Rated Current
V			A
660	50 193 20	Ø 27 x 60 mm	20-250
	50 194 20		
	50 170 20		

Bemessungsausschaltvermögen / Rated breaking capacity **200 kA (AC 660 V)**

Bemessungsstrom Rated Current	Artikel Nr. Article No.			Gewicht Weight	Bemessungs- spannung Rated Voltage	Schmelz- integral Pre-Arcing- I <sup>2</sup> t-Value	Ausschalt- integral Total I <sup>2</sup> t-Value @ AC 660 V	Leistungs- abgabe Power Loss
	ohne Auslöser without striker	mit Auslöser with striker	mit Anschlußlaschen with bolted contacts					
	A							
20	50 193 20.20	50 194 20.20	50 170 20.20	0,10	660	17	100	8
25	50 193 20.25	50 194 20.25	50 170 20.25	0,10	660	30	180	9
32	50 193 20.32	50 194 20.32	50 170 20.32	0,10	660	67	400	10
40	50 193 20.40	50 194 20.40	50 170 20.40	0,10	660	90	550	13
50	50 193 20.50	50 194 20.50	50 170 20.50	0,10	660	150	900	15
63	50 193 20.63	50 194 20.63	50 170 20.63	0,10	660	330	2.000	16
80	50 193 20.80	50 194 20.80	50 170 20.80	0,10	660	472	2.900	22
100	50 193 20.100	50 194 20.100	50 170 20.100	0,10	660	850	5.400	25
125	50 193 20.125	50 194 20.125	50 170 20.125	0,10	660	1.310	7.900	30
160	50 193 20.160	50 194 20.160	50 170 20.160	0,10	660	2.950	17.700	32
200	50 193 20.200	50 194 20.200	50 170 20.200	0,10	660	5.000	30.000	37
250	50 193 20.250	50 194 20.250	50 170 20.250	0,10	660	8.100	49.000	43

Applikationskoeffizienten / Application coefficients (Weiterführende Informationen siehe Seite 13 / for more information see page 13)

a	A2	B1 max.	B2	CF3
130	0,6	1,25	0,6	0,8



660 V

Ø 27 x 60 mm

Zeit/Strom-Kennlinien  
Time-current characteristics

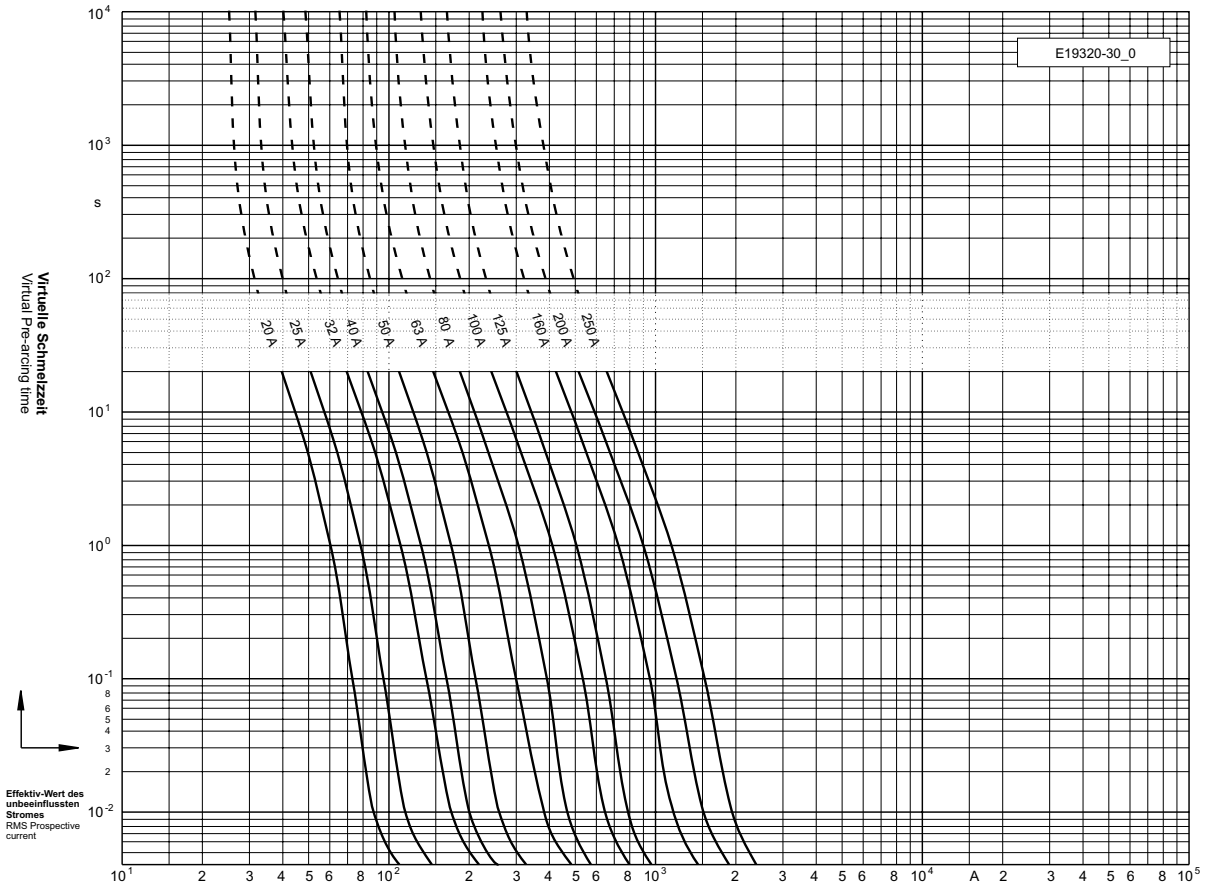

Durchlass-Strom  
Cut-off current

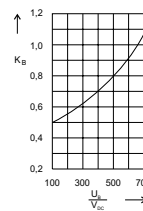
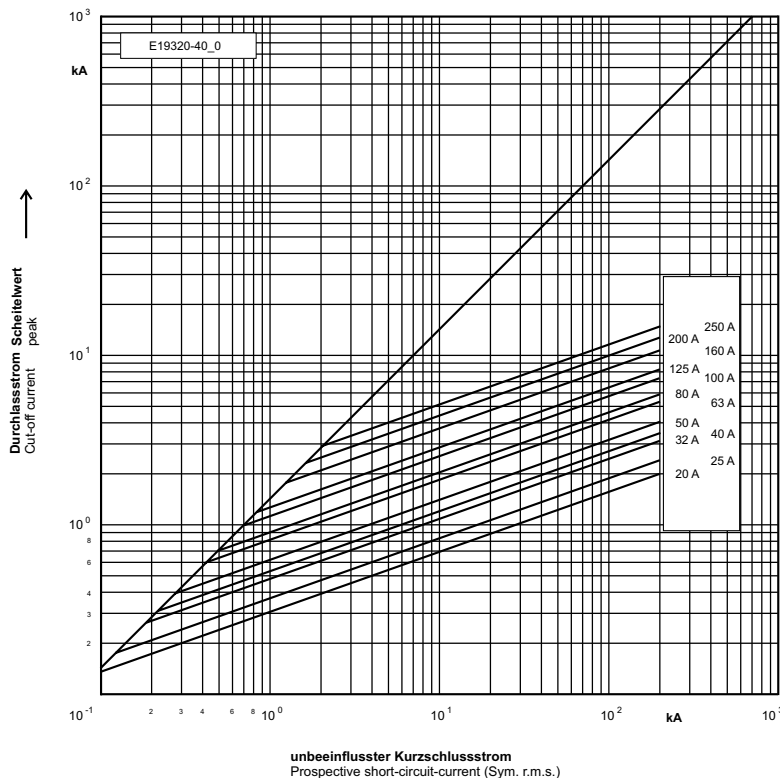

Umrechnungsfaktor für den Ausschalt  $i^2t$ -Wert  
Reduction factor for total  $i^2t$ -value

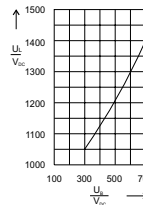

Schaltspannungsdiagramm  
Arc Voltage-Diagram

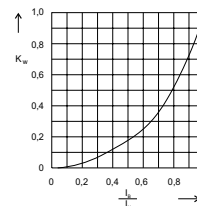

Umrechnungsfaktor der Leistungsabgabe  
Reduction factor for power loss

**690 V**

**Ø 10 x 38 mm**

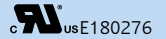

Verpackungseinheit / Packing unit: 10 Stück / 10 pieces

Betriebsklasse / Class <b>gR</b>	<b>DIN EN 60269-4</b> <b>IEC 60 269-4</b> <b>VDE 0636-4</b>	<b>UL 248-13</b>
-------------------------------------	---	------------------

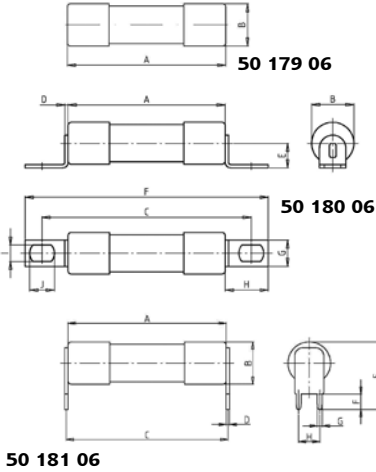

Bemessungs- spannung Rated Voltage	Artikel Article	Größe Size	Länge Length									
			A	B	C	D	E	F	G	H	I	J
V			mm	mm	mm	mm	mm	mm	mm	mm	mm	mm
690	50 179 06	10	38	10,3	-	-	-	-	-	-	-	-
	50 180 06	x	38	10,3	50,6	0,8	6,0	58,8	6,4	10,4	4,0	6,0
	50 181 06	38	38	10,3	38,8	0,8	16,4	3,8	1,2	5,1	-	-

Bemessungsausschaltvermögen / Rated breaking capacity **200 kA**

Bemessungs- strom Rated Current	Artikel Nr. Article No.			Gewicht Weight	Bemessungs- spannung Rated Voltage		Schmelz- integral Pre- Arcing- I <sup>2</sup> t-Value	Ausschalt- integral Total I <sup>2</sup> t-Value @ AC 660 V	Leistungs- abgabe Power Loss
		mit Anschlußlaschen with bolted contacts	mit Einlötpins for PCB mounting		IEC 60269-4	UL 248-13			
	A				kg / 1	V			
1	50 179 06.1	50 180 06.1	50 181 06.1	0,01	690	700	0,13	1,6	1,0
2	50 179 06.2	50 180 06.2	50 181 06.2	0,01	690	700	0,64	8,0	1,8
3	50 179 06.3	50 180 06.3	50 181 06.3	0,01	690	700	2,6	32	1,6
4	50 179 06.4	50 180 06.4	50 181 06.4	0,01	690	700	0,8	10	1,1
5	50 179 06.5	50 180 06.5	50 181 06.5	0,01	690	700	2,0	25	1,5
6	50 179 06.6	50 180 06.6	50 181 06.6	0,01	690	700	3,0	38	1,8
8	50 179 06.8	50 180 06.8	50 181 06.8	0,01	690	700	3,1	39	1,8
10	50 179 06.10	50 180 06.10	50 181 06.10	0,01	690	700	5,1	64	2,3
12	50 179 06.12	50 180 06.12	50 181 06.12	0,01	690	700	7,4	93	2,8
16	50 179 06.16	50 180 06.16	50 181 06.16	0,01	690	700	13	164	3,7
20	50 179 06.20	50 180 06.20	50 181 06.20	0,01	690	700	29	360	4,7
25	50 179 06.25	50 180 06.25	50 181 06.25	0,01	690	700	52	650	5,4
30	50 179 06.30	50 180 06.30	50 181 06.30	0,01	690	700	81	1.010	6,4

Applikationskoeffizienten / Application coefficients (Weiterführende Informationen siehe Seite 13 / for more information see page 13)

a	A2	B1 max.	B2	CF3
150	0,6	1,25	0,5	0,8

690 V

Ø 10 x 38 mm

**RU** usE180276

Zeit/Strom-  
Kennlinien  
Time-current  
characteristics

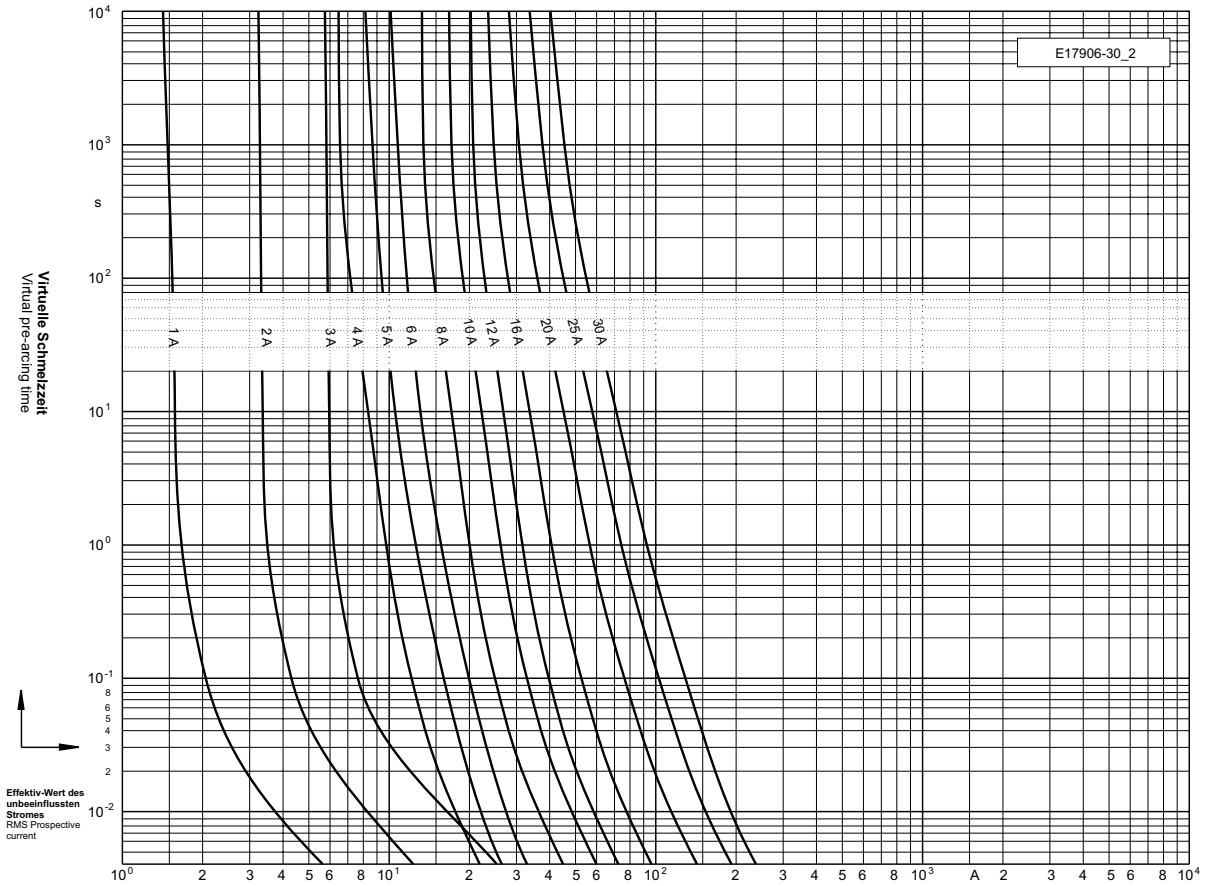

Durchlass-Strom  
Cut-off current

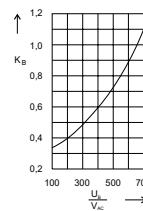
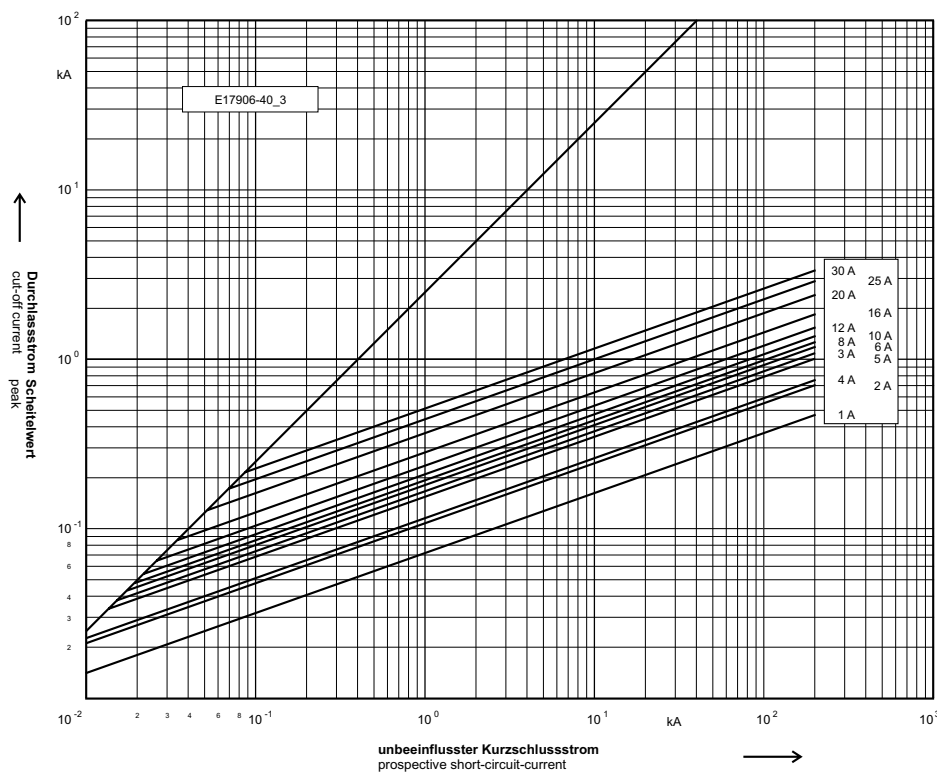

Umrechnungsfaktor  
für den  
Ausschalt  $i^2t$ -Wert  
Reduction factor  
for total  $i^2t$ -value

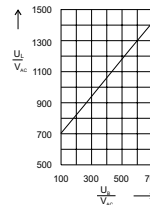

Schaltspannungs-  
diagramm  
Arc Voltage-Diagramm

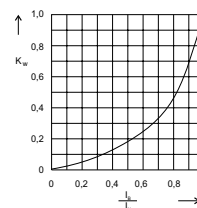

Umrechnungsfaktor  
der  
Leistungsabgabe  
Reduction factor  
for power Loss

**690 V**

**Ø 14 x 51 mm**

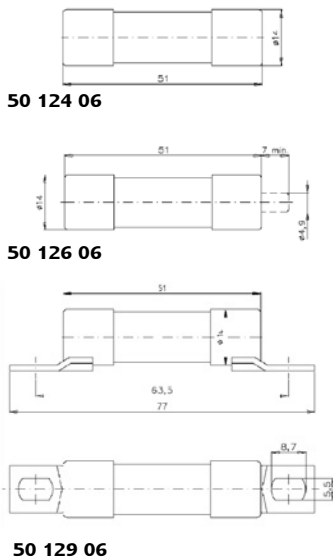
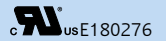

Verpackungseinheit / Packing unit: 10 Stück / 10 pieces

Betriebsklasse / Class <b>gR</b>	IEC 60 269-4 VDE 0636-4	UL 248-13
-------------------------------------	----------------------------	-----------

Bemessungs- spannung Rated Voltage	Artikel Nr. Article No	Größe Size	Bemessungsstrom Rated Current
V			A
690	50 124 06	Ø 14 x 51 mm	1-50
	50 126 06		
	50 129 06		

Bemessungsausschaltvermögen / Rated breaking capacity 200 kA

Bemessungs- strom Rated Current	Artikel Nr. Article No.			Gewicht Weight	Bemessungs- spannung Rated Voltage		Schmelz- integral Pre- Arcing- I <sup>2</sup> t-Value	Ausschalt- integral Total I <sup>2</sup> t-Value @ AC 660 V	Leistungs- abgabe Power Loss
	ohne Auslöser without striker	mit Auslöser with striker	ohne Auslöser without striker Stichmaß / fixing center 63,5 mm		IEC 60269-4	UL 248-13			
	A				V	V			
1	50 124 06.1	50 126 06.1	50 129 06.1	0,02	690	-	0,6	1,9	0,5
2	50 124 06.2	50 126 06.2	50 129 06.2	0,02	690	-	2,6	7,7	1,0
3	50 124 06.3	50 126 06.3	50 129 06.3	0,02	690	-	5	15	1,5
4	50 124 06.4	50 126 06.4	50 129 06.4	0,02	690	-	10	30	2,0
6	50 124 06.6	50 126 06.6	50 129 06.6	0,02	690	700	2,9	18	1,3
8	50 124 06.8	50 126 06.8	50 129 06.8	0,02	690	700	5,1	28	1,7
10	50 124 06.10	50 126 06.10	50 129 06.10	0,02	690	700	7,7	39	2,6
12	50 124 06.12	50 126 06.12	50 129 06.12	0,02	690	700	8,1	75	3,1
16	50 124 06.16	50 126 06.16	50 129 06.16	0,02	690	700	11	115	4,7
20	50 124 06.20	50 126 06.20	50 129 06.20	0,02	690	700	21	190	6,0
25	50 124 06.25	50 126 06.25	50 129 06.25	0,02	690	700	32	340	7,6
32	50 124 06.32	50 126 06.32	50 129 06.32	0,02	690	700	63	620	9,5
40	50 124 06.40	50 126 06.40	50 129 06.40	0,02	690	700	140	1.050	10
50	50 124 06.50	50 126 06.50	50 129 06.50	0,02	690	700	250	1.900	12

Applikationskoeffizienten / Application coefficients (Weiterführende Informationen siehe Seite 13 / for more information see page 13)

a	A2	B1 max.	B2	CF3
170	0,6	1,25	0,6	0,8

690 V

Ø 14 x 51 mm

**RU** usE180276

**Zeit/Strom-Kennlinien**  
Time-current characteristics

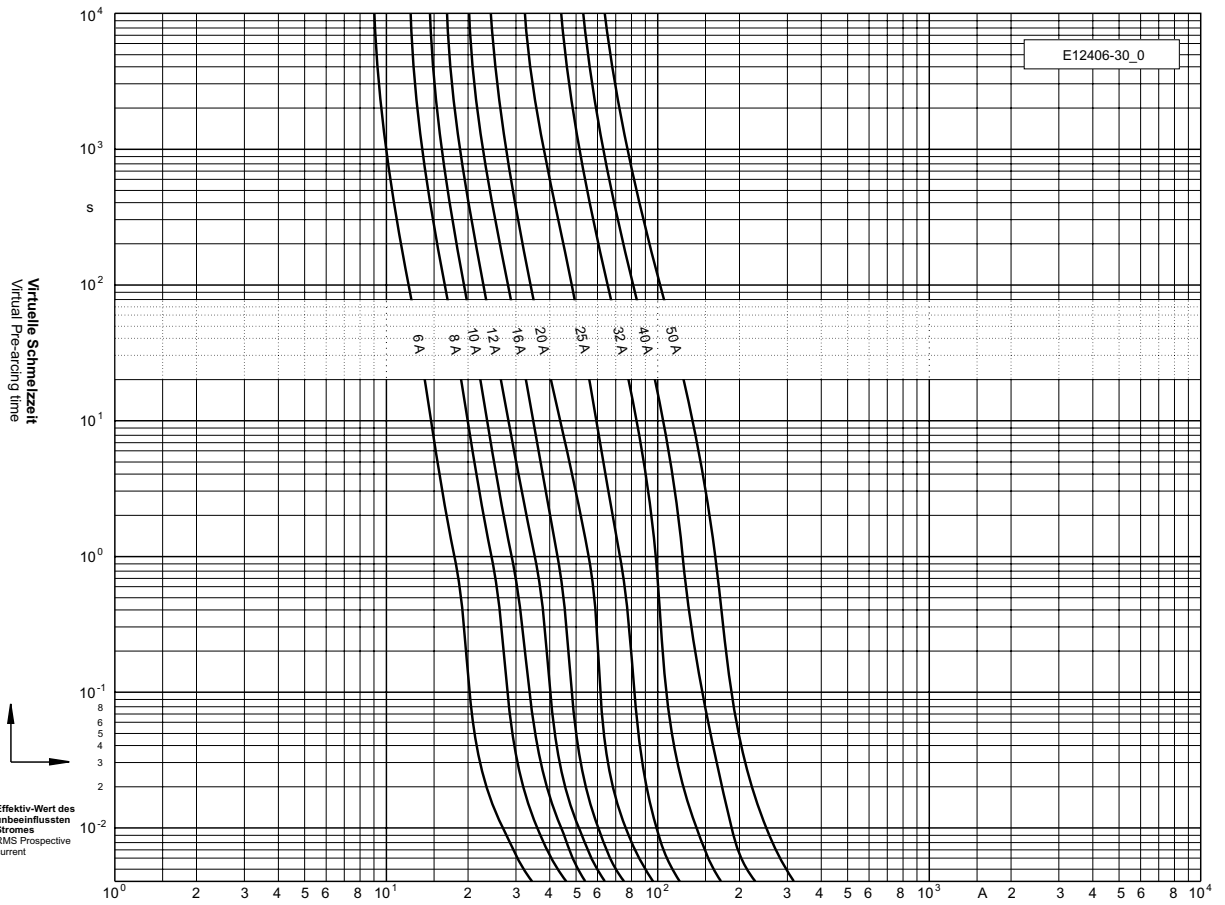

**Durchlass-Strom**  
Cut-off current

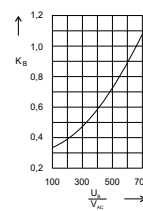
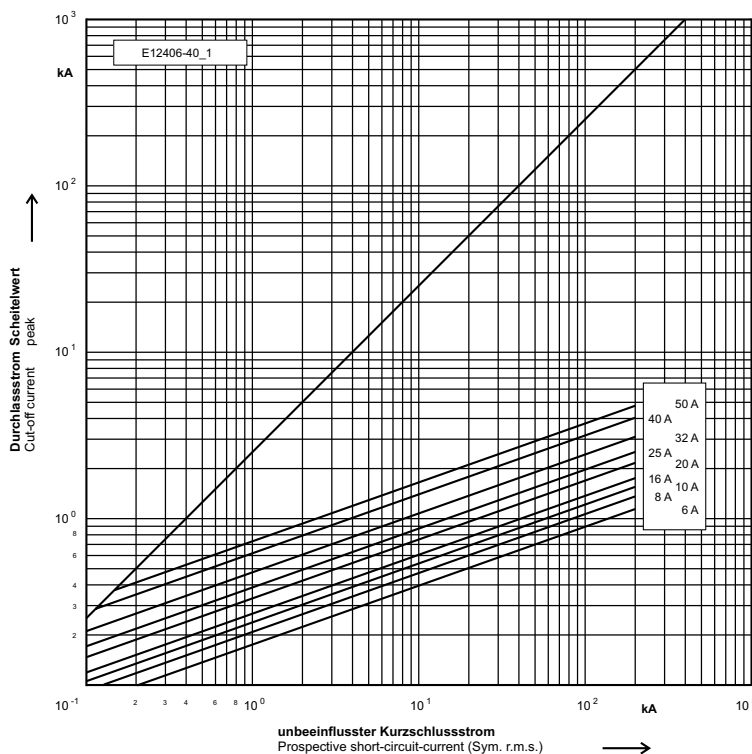

**Umrechnungsfaktor für den Ausschalt  $i^2t$ -Wert**  
Reduction factor for total  $i^2t$ -value

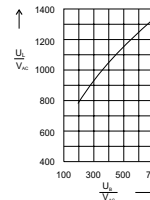

**Schaltspannungsdiagramm**  
Arc Voltage-Diagram

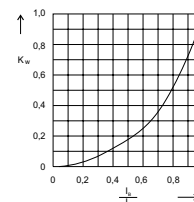

**Umrechnungsfaktor der Leistungsabgabe**  
Reduction factor for power loss

**690 V**

**Ø 14 x 51 mm**

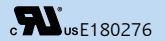

Verpackungseinheit / Packing unit: 10 Stück / 10 pieces

Betriebsklasse / Class  
**gRL (gS)**

**IEC 60 269-4**  
**VDE 0636-4**  
**UL 248-13**

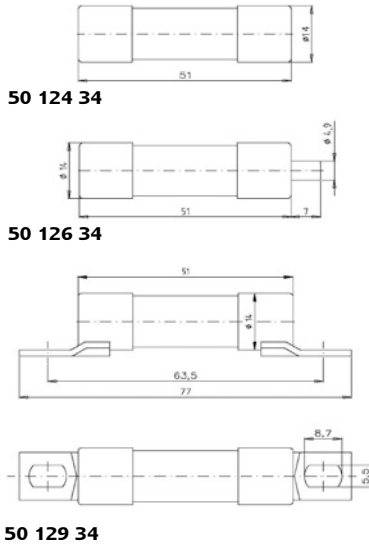

Bemessungs- spannung Rated Voltage	Artikel Nr. Article No	
V		
690 / 700	50 124 34	ohne Auslöser without striker
	50 126 34	mit Auslöser ( min. Ansprechspg. 10V) with striker (min. operating Voltage 10V)
	50 129 34	ohne Auslöser, Stichmaß 63 mm without striker, fixing center 63 mm

**Bemessungsausschaltvermögen / Rated breaking capacity 200 kA AC 700 V**  
**30 kA DC 440 V**  
**L/R = 30 mS**

Bemessungs- strom Rated Current	Artikel Nr. Article No.			Gewicht Weight	Bemessungsspannung Rated Voltage			Schmelz- integral Pre- Arcing- I <sup>2</sup> t-Value	Ausschaltintegral Total I <sup>2</sup> t-Value		Leistungs- abgabe Power Loss
	ohne Auslöser without striker	mit Auslöser with striker	ohne Auslöser without striker Stichmaß / fixing center 63,5 mm		IEC 60269-4	UL 248-13	DC		@ AC 690 V	@ DC 440 V L/R=30mS	
10	50 124 34.10	50 126 34.10	50 129 34.10	0,02	690	700	440	8	60	70	1,9
12	50 124 34.12	50 126 34.12	50 129 34.12	0,02	690	700	440	12	90	105	2,3
16	50 124 34.16	50 126 34.16	50 129 34.16	0,02	690	700	440	25	190	210	2,8
20	50 124 34.20	50 126 34.20	50 129 34.20	0,02	690	700	440	46	340	400	3,0
25	50 124 34.25	50 126 34.25	50 129 34.25	0,02	690	700	440	100	740	850	3,2
30	50 124 34.30	50 126 34.30	50 129 34.30	0,02	690	700	440	190	1.400	1.600	3,8
32	50 124 34.32	50 126 34.32	50 129 34.32	0,02	690	700	440	250	1.900	2.100	4,0
35	50 124 34.35	50 126 34.35	50 129 34.35	0,02	690	700	440	370	2.800	3.150	4,2
40	50 124 34.40	50 126 34.40	50 129 34.40	0,02	690	700	440	420	3.100	3.600	4,4

Applikationskoeffizienten / Application coefficients (Weiterführende Informationen siehe Seite 13 / for more information see page 13)

a	A2	B1 max.	B2	Cf3
130	1,0	1,25	0,5	0,8

690 V

Ø 14 x 51 mm

cULus E180276

Zeit/Strom-  
Kennlinien  
Time-current  
characteristics

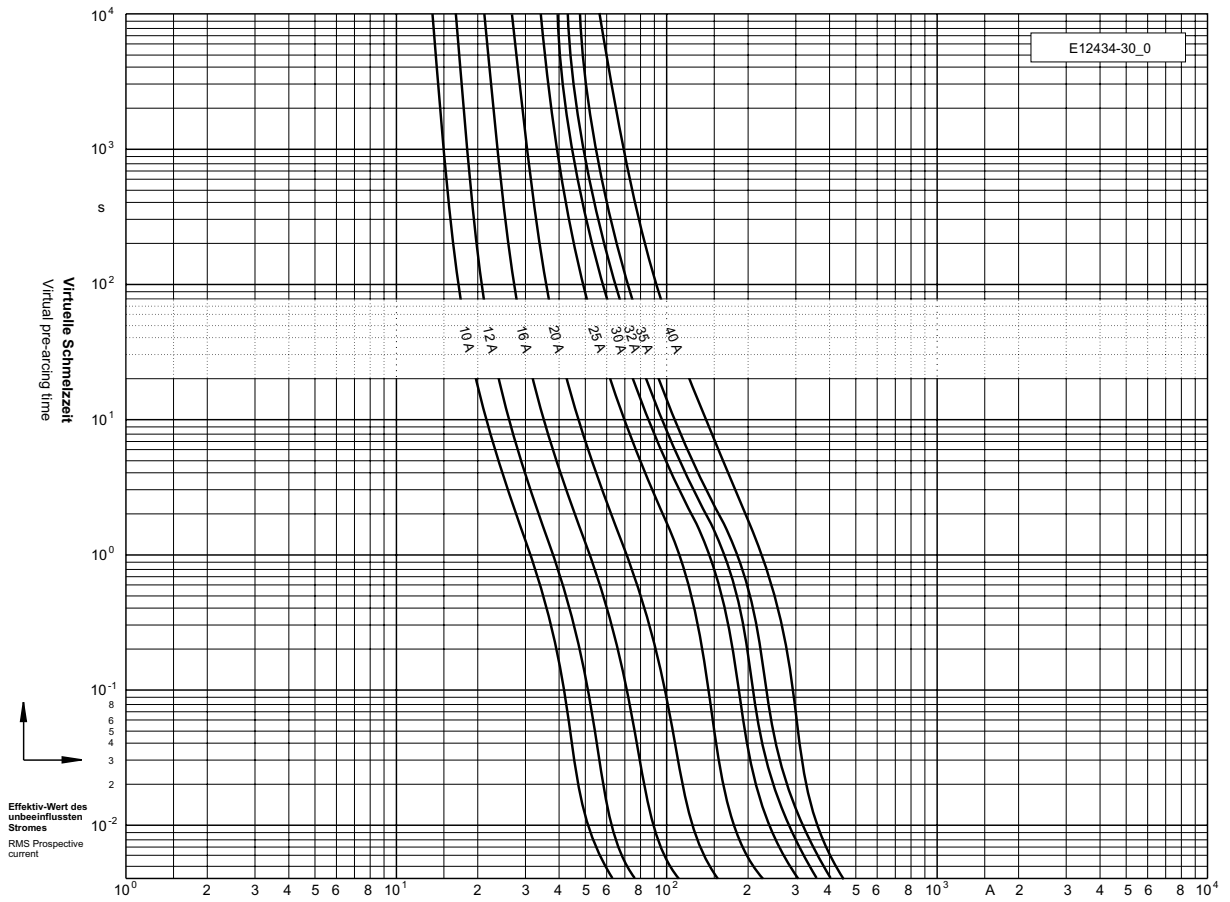

Durchlass-Strom  
Cut-off current

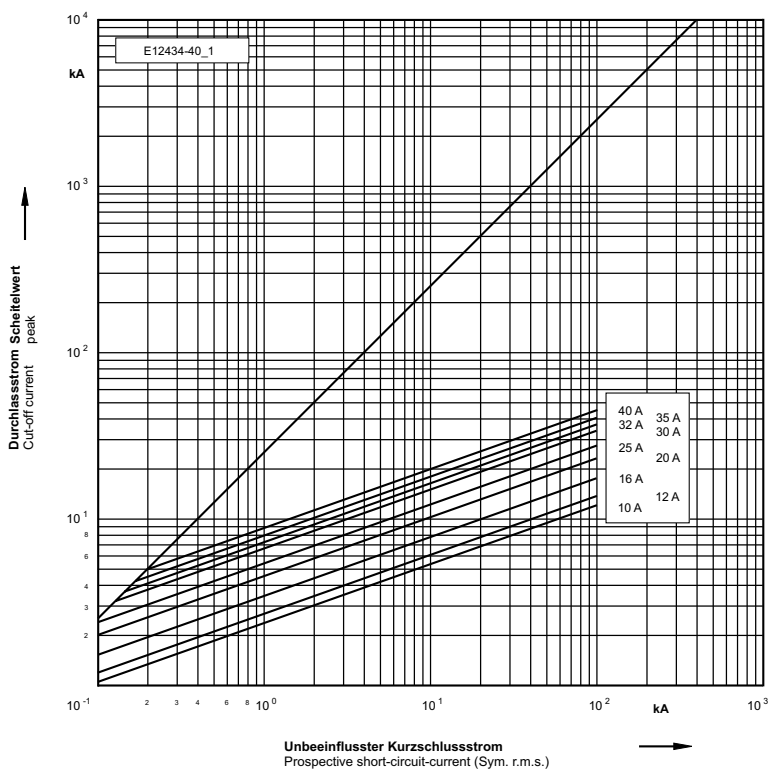

**690 V**

**Ø 22 x 58 mm**

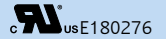

Verpackungseinheit / Packing unit: 10 Stück / 10 pieces

Betriebsklasse / Class ≤ 100 A: gR > 100 A: aR	DIN EN 60269-4 IEC 60 269-4 VDE 0636-4	UL 248-13
--	--	-----------

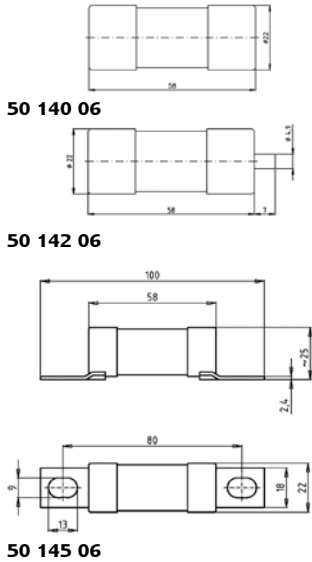

Bemessungs- spannung Rated Voltage	Artikel Nr. Article No	
V		
690 / 700	50 140 06	ohne Auslöser without striker
	50 142 06	mit Auslöser ( min. Ansprechspg. 10V) with striker (min. operating Voltage 10V)
	50 145 06	ohne Auslöser, Stichmaß 80 mm without striker, fixing center 80 mm

Bemessungsausschaltvermögen / Rated breaking capacity 200 kA AC 700 V

Bemessungs- strom Rated Current	Artikel Nr. Article No.			Gewicht Weight kg / 1	Bemessungsspan- nung Rated Voltage		Schmelz- integral Pre-Arcing- I <sup>2</sup> t-Value	Ausschalt- integral Total I <sup>2</sup> t-Value @ AC 660 V	Leistungs- abgabe Power Loss W
	ohne Auslöser without striker	mit Auslöser with striker	ohne Auslöser without striker Stichmaß / fixing center 80 mm		IEC 60269-4	UL 248-13			
	A				V	V			
6	50 140 06.6	50 142 06.6	50 145 06.6	0,06	690	700	2	10	3,0
8	50 140 06.8	50 142 06.8	50 145 06.8	0,06	690	700	4	20	3,5
10	50 140 06.10	50 142 06.10	50 145 06.10	0,06	690	700	6	30	4,0
12	50 140 06.12	50 142 06.12	50 145 06.12	0,06	690	700	8	35	4,8
16	50 140 06.16	50 142 06.16	50 145 06.16	0,06	690	700	12	53	5,5
20	50 140 06.20	50 142 06.20	50 145 06.20	0,06	690	700	21	91	6,0
25	50 140 06.25	50 142 06.25	50 145 06.25	0,06	690	700	32	140	7,2
32	50 140 06.32	50 142 06.32	50 145 06.32	0,06	690	700	63	315	9,6
40	50 140 06.40	50 142 06.40	50 145 06.40	0,06	690	700	140	610	12
50	50 140 06.50	50 142 06.50	50 145 06.50	0,06	690	700	210	910	15
63	50 140 06.63	50 142 06.63	50 145 06.63	0,06	690	700	510	2.260	16
80	50 140 06.80	50 142 06.80	50 145 06.80	0,06	690	700	1.000	4.400	18
100	50 140 06.100	50 142 06.100	50 145 06.100	0,06	690	700	2.050	8.900	19
125	50 140 06.125	50 142 06.125	50 145 06.125	0,06	690	-	3.000	22.000	23
135	50 140 06.135	50 142 06.135	50 145 06.135	0,06	690	-	3.500	25.000	26

Applikationskoeffizienten / Application coefficients (Weiterführende Informationen siehe Seite 13 / for more information see page 13)

a	A2	B1 max.	B2	CF3
170	0,6	1,25	0,6	0,8



690 V

Ø 22 x 58 mm

**RU** usE180276

**Zeit/Strom-Kennlinien**  
Time-current characteristics

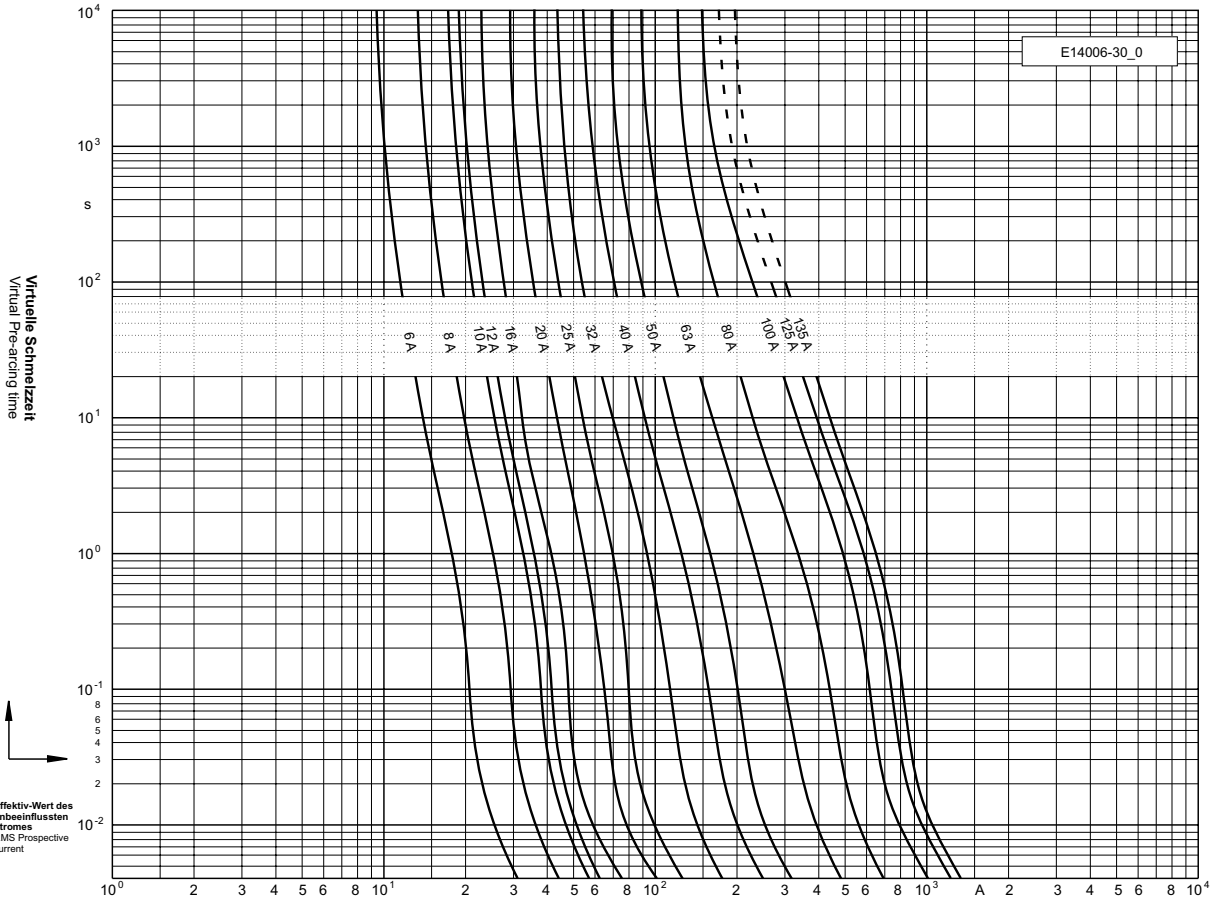

**Durchlass-Strom**  
Cut-off current

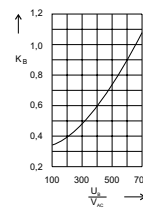
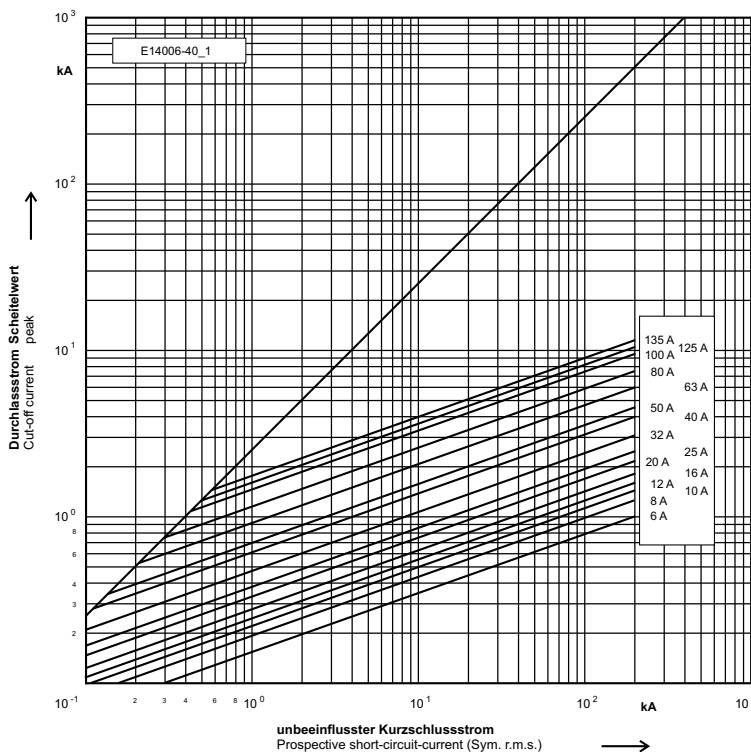

**Umrechnungsfaktor für den Ausschalt i<sup>2</sup>t-Wert**  
Reduction factor for total i<sup>2</sup>t-value

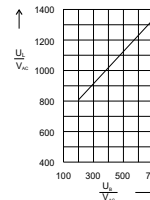

**Schaltspannungsdiagramm**  
Arc Voltage-Diagram

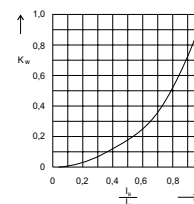

**Umrechnungsfaktor der Leistungsabgabe**  
Reduction factor for power Loss

**690 V**

**Ø 22 x 58 mm**

**usE180276**

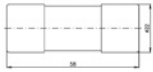

50 140 34

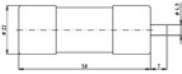

50 142 34

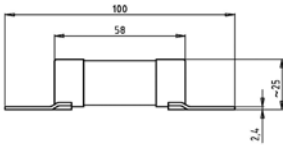

50 145 34

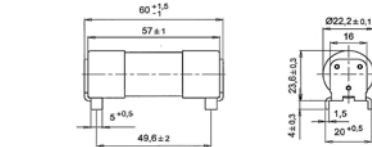

50 146 34

Verpackungseinheit / Packing unit: 10 Stück / 10 pieces

Betriebsklasse / Class <b>gRL (gS)</b>	<b>DIN EN 60269-4</b> <b>IEC 60 269-4</b> <b>VDE 0636-4</b>	<b>UL 248-13</b>
---	---	------------------

Bemessungs- spannung Rated Voltage	Artikel Nr. Article No	
V		
690 / 700 DC 440	50 140 34	ohne Auslöser without striker
	50 142 34	mit Auslöser ( min. Ansprechspg. 10V) with striker (min. operating Voltage 10V)
	50 145 34	ohne Auslöser, Stichmaß 80 mm without striker, fixing center 80 mm
	50 146 34	mit Einlötpins with soldering contacts

**Bemessungsausschaltvermögen / Rated breaking capacity 200 kA AC 700 V**  
**30 kA DC 440 V**  
**L/R = 30 mS**

Bemessungs- strom Rated Current	Artikel Nr. Article No.				Gewicht Weight	Bemessungs- spannung Rated Voltage		Schmelz- integral Pre- Arcing- I <sup>2</sup> t-Value	Ausschalt- integral Total I <sup>2</sup> t-Value @ AC 660 V	Leistungs- abgabe Power Loss
	ohne Auslöser without striker	mit Auslöser with striker	mit Schraub- kontakt with bolted connections	mit Einlötpins with soldering contacts		IEC 60269-4	UL 248-13			
	A					V	V			
25	50 140 34.25	50 142 34.25	50 145 34.25	50 146 34.25	0,06	690	700	100	800	3,6
30	50 140 34.30	50 142 34.30	50 145 34.30	50 146 34.30	0,06	690	700	190	1.500	4,6
32	50 140 34.32	50 142 34.32	50 145 34.32	50 146 34.32	0,06	690	700	250	2.000	4,8
35	50 140 34.35	50 142 34.35	50 145 34.35	50 146 34.35	0,06	690	700	370	3.000	5,0
40	50 140 34.40	50 142 34.40	50 145 34.40	50 146 34.40	0,06	690	700	420	3.400	5,2
50	50 140 34.50	50 142 34.50	50 145 34.50	50 146 34.50	0,06	690	700	870	7.000	5,4
63	50 140 34.63	50 142 34.63	50 145 34.63	50 146 34.63	0,06	690	700	1.300	10.500	6,8
80	50 140 34.80	50 142 34.80	50 145 34.80	50 146 34.80	0,06	690	700	2.500	20.000	7,5
100	50 140 34.100	50 142 34.100	50 145 34.100	50 146 34.100	0,06	690	700	4.600	37.000	9,7

Applikationskoeffizienten / Application coefficients (Weiterführende Informationen siehe Seite 13 / for more information see page 13)

a	A2	B1 max.	B2	CF3
130	1,0	1,25	0,6	0,8

**690 V**

**Ø 22 x 58 mm**

**usE180276**

**Zeit/Strom-Kennlinien**  
Time-current characteristics

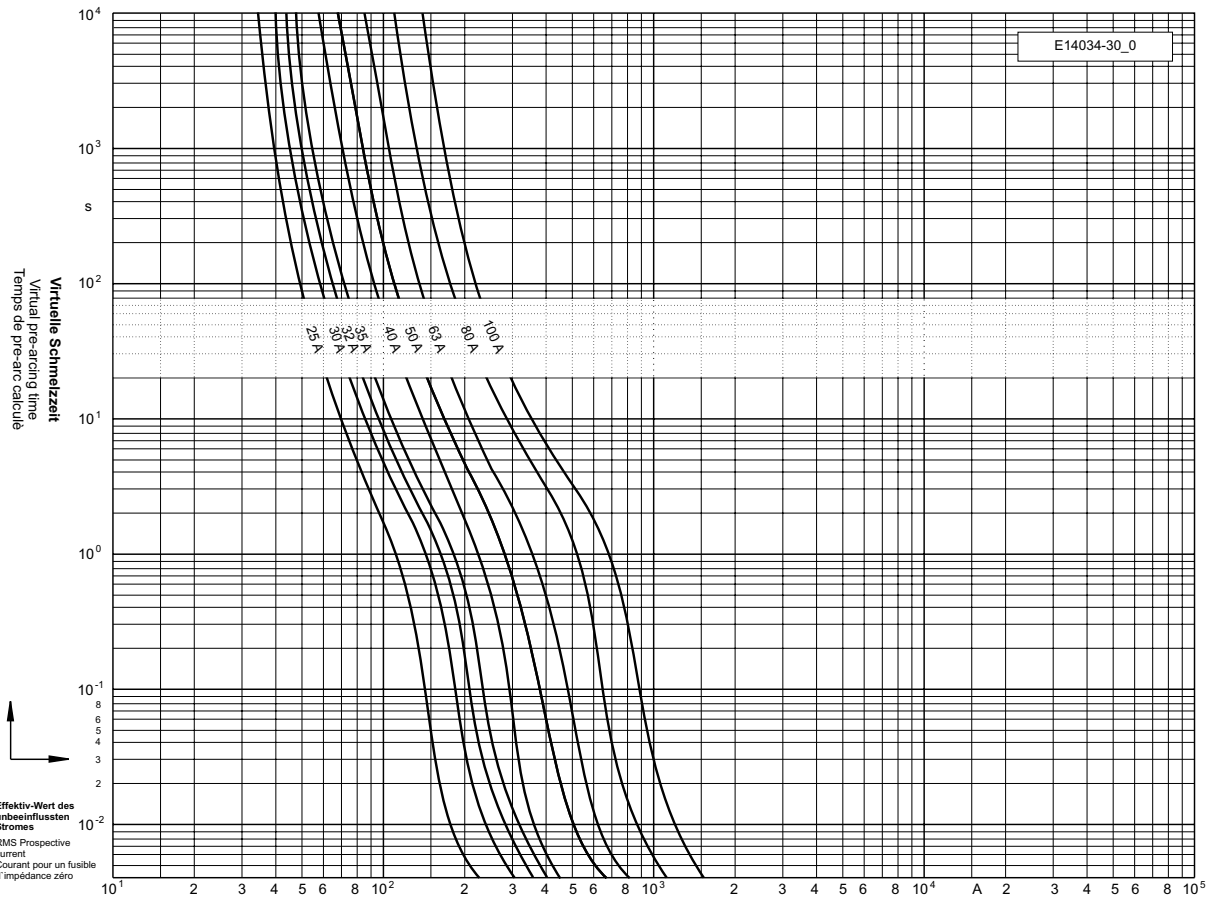

**Durchlass-Strom**  
Cut-off current

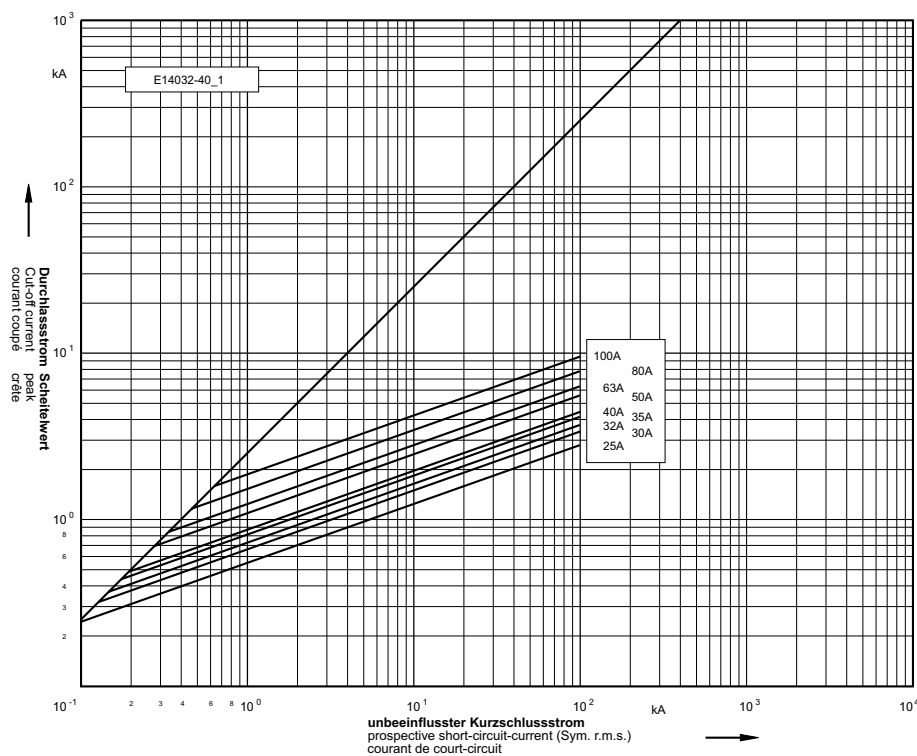

**1000 V**

**Ø 27 x 60 mm**

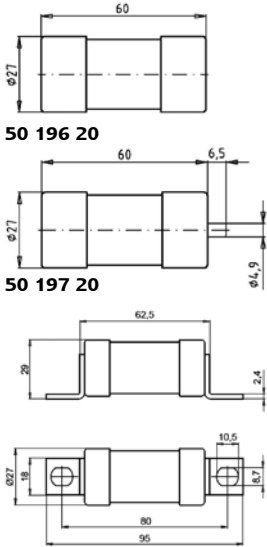

50 196 20

50 197 20

50 198 20

Verpackungseinheit / Packing unit: 10 Stück / 10 pieces

Betriebsklasse / Class <b>aR</b>	<b>IEC 60 269-4</b> <b>VDE 0636-40</b>
-------------------------------------	---

Bemessungs- spannung Rated Voltage	Artikel Nr. Article No	Größe Size	Bemessungsstrom Rated Current
V			A
1000	50 196 20	Ø 27 x 60 mm	25-170
	50 197 20		
	50 198 20		

Bemessungsausschaltvermögen / Rated breaking capacity 100 kA (AC 1000 V)

Bemessungs- strom Rated Current	Artikel Nr. Article No.			Gewicht Weight	Bemessungs- spannung Rated voltage	Schmelz- integral Pre-Arcing- I <sup>2</sup> t-Value	Ausschalt- integral Total I <sup>2</sup> t-Value @ AC 1000 V	Leistungs- abgabe Power Loss
	ohne Auslöser without striker	mit Auslöser with striker	Stichmaß 80mm fixing center 80mm					
A				kg / 1	V	A <sup>2</sup> s	A <sup>2</sup> s	W
25	50 196 20.25	50 197 20.25	20 198 20.25	0,09	1000	21	135	15
32	50 196 20.32	50 197 20.32	20 198 20.32	0,09	1000	32	210	17
40	50 196 20.40	50 197 20.40	20 198 20.40	0,09	1000	82	530	17
50	50 196 20.50	50 197 20.50	20 198 20.50	0,09	1000	141	920	20
63	50 196 20.63	50 197 20.63	20 198 20.63	0,09	1000	250	1.630	22
80	50 196 20.80	50 197 20.80	20 198 20.80	0,09	1000	512	3.330	24
100	50 196 20.100	50 197 20.100	20 198 20.100	0,09	1000	1.000	6.500	26
125	50 196 20.125	50 197 20.125	20 198 20.125	0,09	1000	2.260	14.700	26
160	50 196 20.160	50 197 20.160	20 198 20.160	0,09	1000	4.600	30.000	34
170	50 196 20.170	50 197 20.170	20 198 20.170	0,09	1000	7.790	50.600	30

Applikationskoeffizienten / Application coefficients (Weiterführende Informationen siehe Seite 13 / for more information see page 13)

a	A2	B1 max.	B2	CF3
130	0,6	1,25	0,6	0,8

1000 V

Ø 27 x 60 mm

Zeit/Strom-Kennlinien  
Time-current characteristics

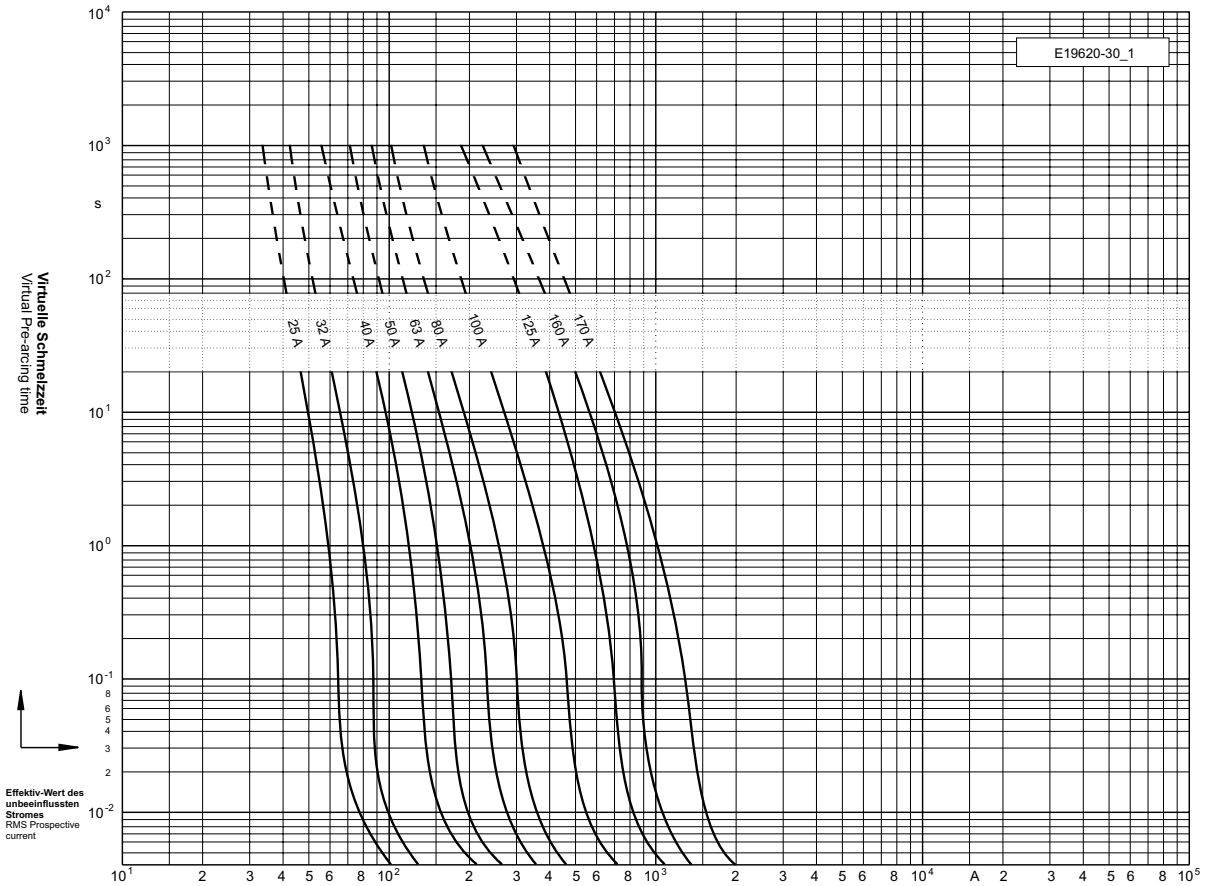

Durchlass-Strom  
Cut-off current

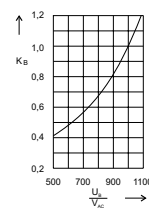
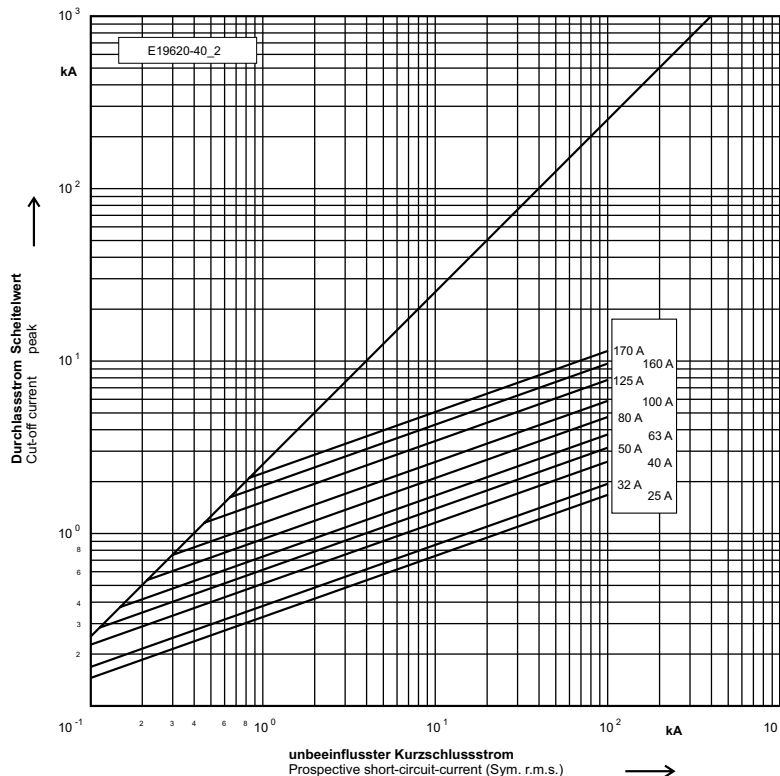

Umrechnungsfaktor für den Ausschalt  $i^2t$ -Wert  
Reduction factor for total  $i^2t$ -value

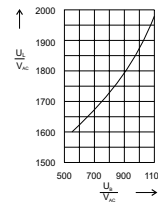

Schaltspannungsdiagramm  
Arc Voltage-Diagram

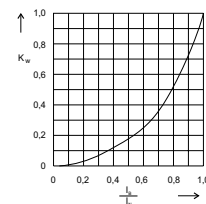

Umrechnungsfaktor der Leistungsabgabe  
Reduction factor for power Loss

**DC 600 V Ø 16 x 137 mm**

Verpackungseinheit / Packing unit: 1 Stück / 1 pieces

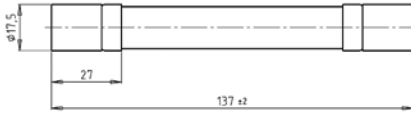

Charakteristik / Class <b>F</b> flick	
---	--

Bemessungs- spannung Rated Voltage	Artikel Nr. Article No	Größe Size	Bemessungsstrom Rated Current
V			A
DC 600	90 079 10	16 x 137 mm	4 - 35

Bemessungsausschaltvermögen / Rated breaking capacity **6 kA**

Bemessungsstrom Rated Current	Artikel Nr. Article No.	Gewicht Weight	Bemessungs- spannung Rated Voltage	Schmelzintegral Pre-Arcing- I <sup>2</sup> t-Value	Leistungsabgabe Power Loss
A		kg / 1	V	A <sup>2</sup> s	W
4	90 079 10.4	0,07	DC 600	6,9	2,3
6	90 079 10.6	0,07	DC 600	17	2,5
10	90 079 10.10	0,07	DC 600	122	3,2
16	90 079 10.16	0,07	DC 600	302	5,1
20	90 079 10.20	0,07	DC 600	490	6,4
35	90 079 10.35	0,07	DC 600	2.050	9,5

Applikationskoeffizienten / Application coefficients (Weiterführende Informationen siehe Seite 13 / for more information see page 13)

a	A2	B1 max.	B2	CF3	
130	0,8	1,25	0,8	0,8	

**DC 600 V Ø 16 x 137 mm**

**Zeit/Strom-  
Kennlinien**  
Time-current  
characteristics

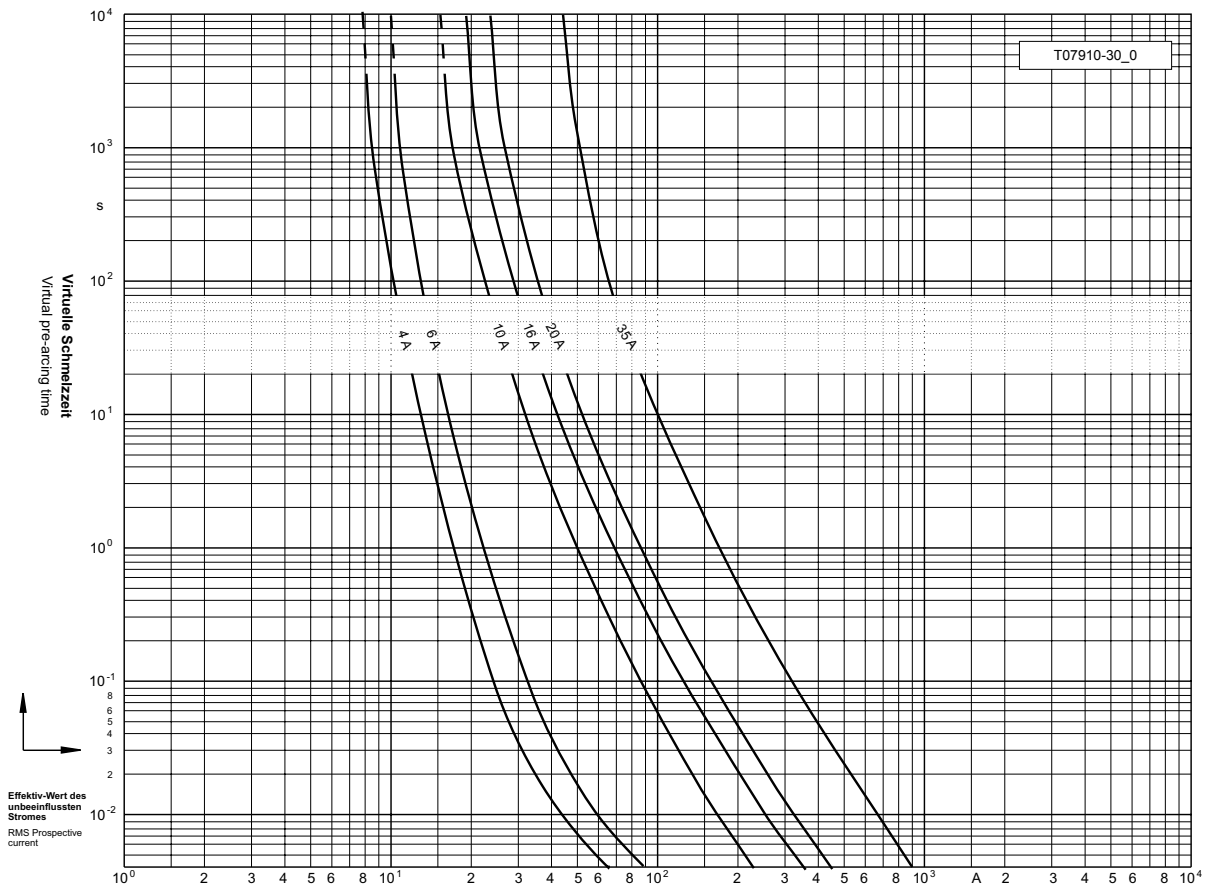

**DC 660 V Ø 27 x 60 mm**

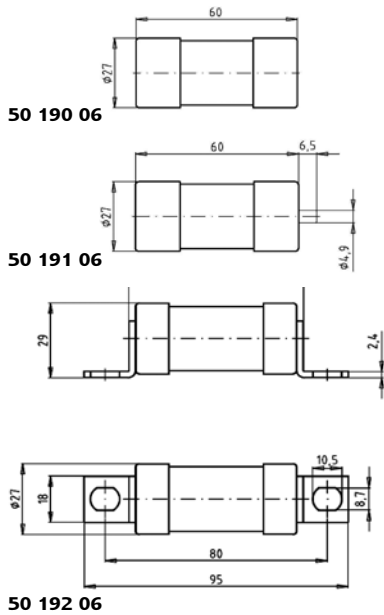
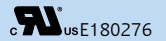

Verpackungseinheit / Packing unit: 10 Stück / 10 pieces

Betriebsklasse / Class <b>gR</b>	DIN EN 60269-4 IEC 60 269-4 VDE 0636-4	UL 248-13
-------------------------------------	--	-----------

Bemessungs- spannung Rated Voltage	Artikel Nr. Article No	Größe Size	Bemessungsstrom Rated Current
V			A
DC 660	50 190 06*	Ø 27 x 60 mm	8-160
	50 191 06		
	50 192 06*		

Bemessungsausschaltvermögen / Rated breaking capacity 30 kA L/R = 10 mS

Bemessungsstrom Rated Current	Artikel Nr. Article No.			Gewicht Weight	Bemessungs- spannung Rated Voltage		Schmelz- integral Pre-Arcing- I <sup>2</sup> t-Value	Ausschalt- integral Total I <sup>2</sup> t-Value	Leistungs- abgabe Power Loss
	ohne Auslöser without striker	mit Auslöser with striker	mit Anschlußlaschen with bolted contacts		IEC 60269-4	UL 248-13			
	A				V	V			
8	50 190 06.8	50 191 06.8	50 192 06.8	0,10	DC 660	660	4	20	2,0
10	50 190 06.10	50 191 06.10	50 192 06.10	0,10	DC 660	660	8	40	2,2
12	50 190 06.12	50 191 06.12	50 192 06.12	0,10	DC 660	660	12	60	2,7
16	50 190 06.16	50 191 06.16	50 192 06.16	0,10	DC 660	660	32	160	3,1
20	50 190 06.20	50 191 06.20	50 192 06.20	0,10	DC 660	660	62	310	3,5
25	50 190 06.25	50 191 06.25	50 192 06.25	0,10	DC 660	660	130	650	3,9
32	50 190 06.32	50 191 06.32	50 192 06.32	0,10	DC 660	660	250	1.250	4,6
40	50 190 06.40	50 191 06.40	50 192 06.40	0,10	DC 660	660	420	2.100	6,6
50	50 190 06.50	50 191 06.50	50 192 06.50	0,10	DC 660	660	620	3.100	7,5
63	50 190 06.63	50 191 06.63	50 192 06.63	0,10	DC 660	660	1.200	6.000	8,9
80	50 190 06.80	50 191 06.80	50 192 06.80	0,10	DC 660	660	2.100	10.500	10,9
100	50 190 06.100	50 191 06.100	50 192 06.100	0,10	DC 660	660	3.500	17.500	13,5
110	50 190 06.110	50 191 06.110	50 192 06.110	0,10	DC 660	660	4.600	23.000	14,2
125	50 190 06.125	50 191 06.125	50 192 06.125	0,10	DC 440	-	7.800	29.600	16,0
160	50 190 06.160	50 191 06.160	50 192 06.160	0,10	DC 440	-	11.800	44.900	19,0

\* UL rec.

Applikationskoeffizienten / Application coefficients (Weiterführende Informationen siehe Seite 13 / for more information see page 13)

a	A2	B1 max.	B2	CF3
130	0,6	1,25	0,6	0,8



**DC 660 V Ø 27 x 60 mm**

c  usE180276

**Zeit/Strom-Kennlinien**  
Time-current characteristics

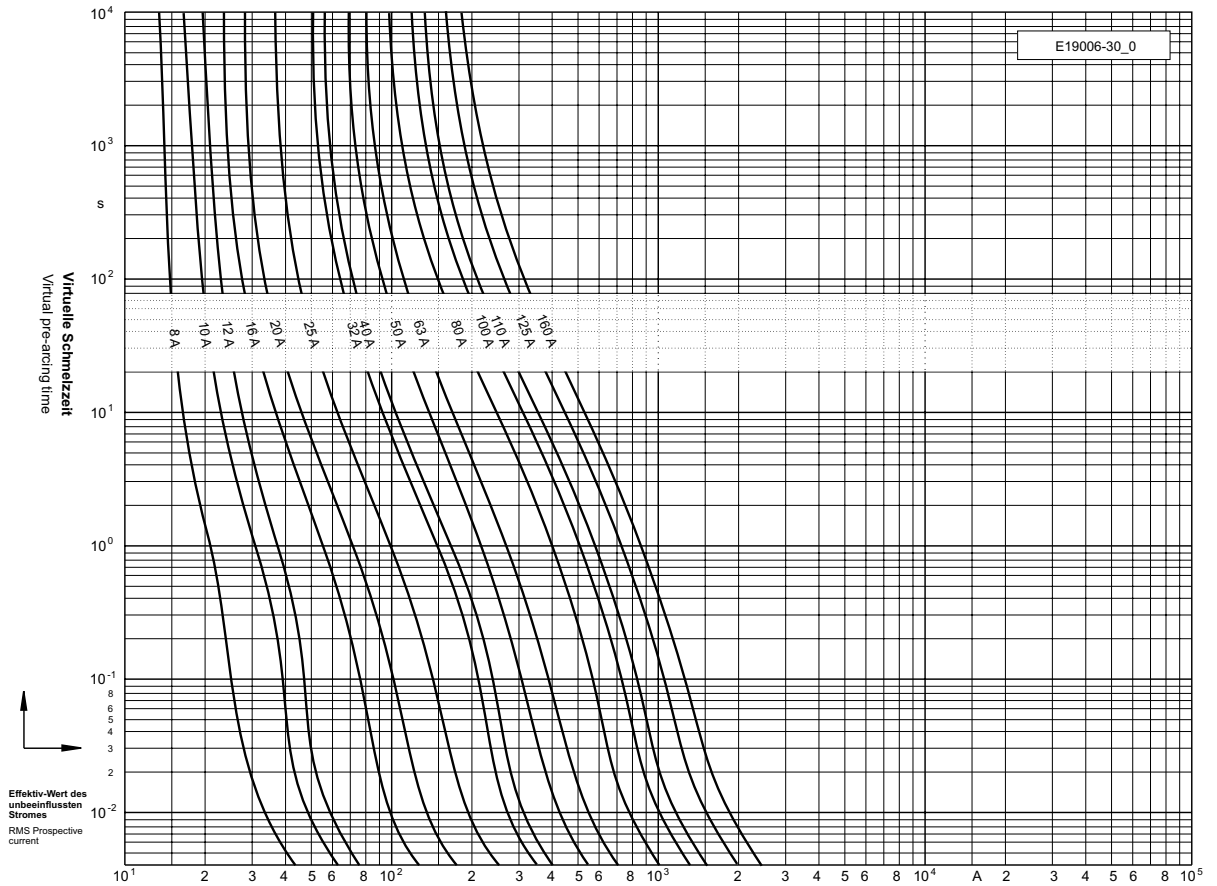

**Durchlass-Strom**  
Cut-off current

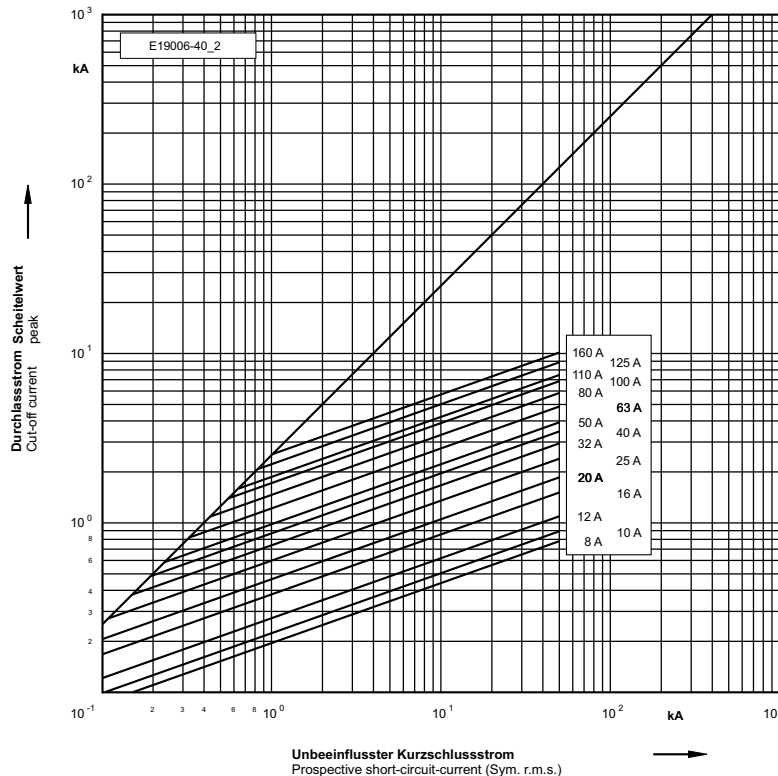

**DC 700 V** **Ø 14 x 51 mm**

 usE180276

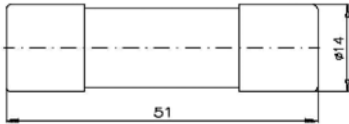

Verpackungseinheit / Packing unit: 10 Stück / 10 pieces

Betriebsklasse / Class <b>aR</b>	<b>UL 248-13</b>
-------------------------------------	------------------

Bemessungs- spannung Rated Voltage	Artikel Nr. Article No	Größe Size	Bemessungsstrom Rated Current
V			A
DC 700	50 118 06	Ø 14 x 51 mm	6-50

Bemessungsausschaltvermögen / Rated breaking capacity 50 kA (DC 700 V)

Bemessungsstrom Rated Current	Artikel Nr. Article No.	Gewicht Weight	Approbationen Approvals	Schmelzintegral Pre-Arcing I <sup>2</sup> t-Value	Ausschaltintegral Total I <sup>2</sup> t-Value @ DC 700 V	Leistungsabgabe Power Loss
A		kg / 1	UL rec.	A <sup>2</sup> s	A <sup>2</sup> s	W
6	50 118 06.6	0,02	*	2,0	12	1,3
8	50 118 06.8	0,02	*	2,9	17	1,7
10	50 118 06.10	0,02	*	3,9	25	2,6
12	50 118 06.12	0,02	*	6,5	41	3,1
16	50 118 06.16	0,02	*	8,0	52	4,7
20	50 118 06.20	0,02	*	12	70	6,0
25	50 118 06.25	0,02	*	20	130	7,6
30	50 118 06.30	0,02	*	32	190	9,8
35	50 118 06.35	0,02	-	72	430	10,3
40	50 118 06.40	0,02	-	103	620	11,2
50	50 118 06.50	0,02	-	128	770	12,6

Applikationskoeffizienten / Application coefficients (Weiterführende Informationen siehe Seite 13 / for more information see page 13)

a	A2	B1 max.	B2	Cf3
130	0,55	1,25	0,6	0,8

**DC 700 V**  $\varnothing 14 \times 51 \text{ mm}$

**RU** <sup>®</sup> usE180276

**Zeit/Strom-Kennlinien**  
Time-current characteristics

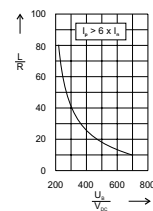
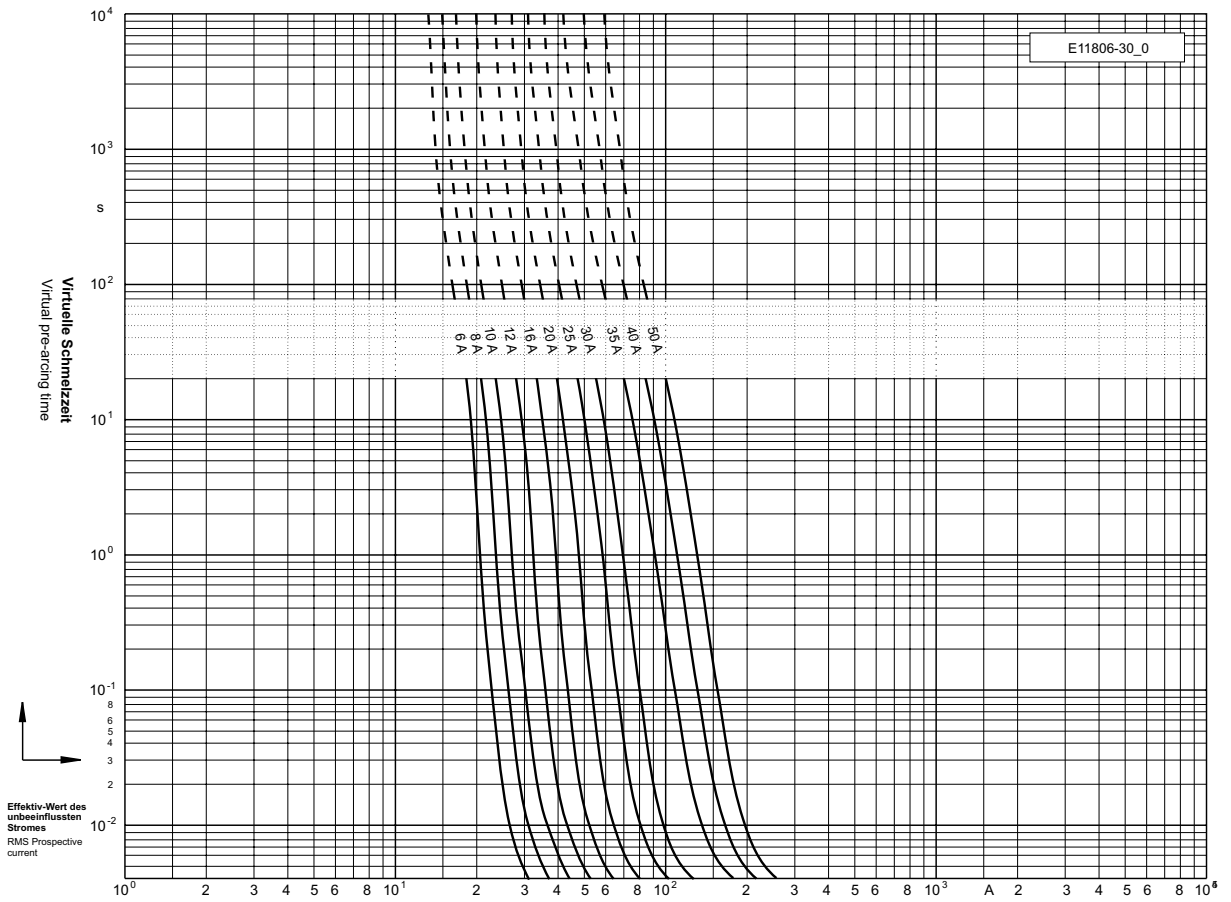

**DC-Anwendung**  
DC-Application

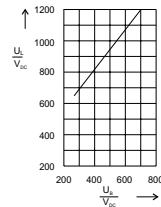

**Schaltspannungsdiagramm**  
Arc Voltage-Diagram

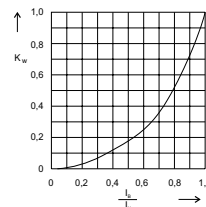

**Umrechnungsfaktor der Leistungsabgabe**  
Reduction factor for power loss

**DC 700 V**  $\varnothing$  14 x 51 mm

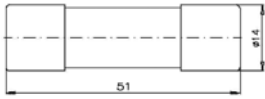
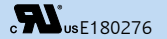

50 201 06

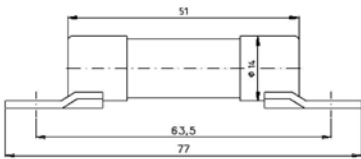

50 202 06

Verpackungseinheit / Packing unit: 10 Stück / 10 pieces

Betriebsklasse / Class <b>aR</b>	<b>UL 248-13</b>
-------------------------------------	------------------

Bemessungs- spannung Rated Voltage	Artikel Nr. Article No	Größe Size	Bemessungsstrom Rated Current
V			A
DC 700	50 201 06*	$\varnothing$ 14 x 51 mm	10-63
	50 202 06	Stichmaß 63.5 mm	

Bemessungsausschaltvermögen / Rated breaking capacity 50 kA (DC 700 V)

Bemessungsstrom Rated Current	Artikel Nr. Article No.	Gewicht Weight	Schmelzintegral Pre-Arcing- I <sup>2</sup> t-Value	Ausschaltintegral Total I <sup>2</sup> t-Value	Leistungsabgabe Power Loss
A		kg / 1	A <sup>2</sup> s	A <sup>2</sup> s	W
10	50 201 06.10* 50 202 06.10	0,02	12	67	1,1
12	50 201 06.12* 50 202 06.12	0,02	20	120	1,2
16	50 201 06.16* 50 202 06.16	0,02	32	190	2,0
20	50 201 06.20* 50 202 06.20	0,02	63	360	2,3
25	50 201 06.25* 50 202 06.25	0,02	82	480	3,1
32	50 201 06.32* 50 202 06.32	0,02	130	740	4,1
40	50 201 06.40* 50 202 06.40	0,02	250	1.460	4,6
50	50 201 06.50* 50 202 06.50	0,02	330	1.900	7
63	50 201 06.63* 50 202 06.63	0,02	512	3.900	9,5

\*Approbationen / Approvals UL rec.

Applikationskoeffizienten / Application coefficients (Weiterführende Informationen siehe Seite 13 / for more information see page 13)

a	A2	B1 max.	B2	Cf3
130	0,55	1,25	0,6	0,8

**DC 700 V**  $\varnothing$  14 x 51 mm

c  usE180276

**Zeit/Strom-Kennlinien**  
Time-current characteristics

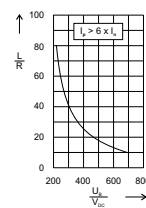
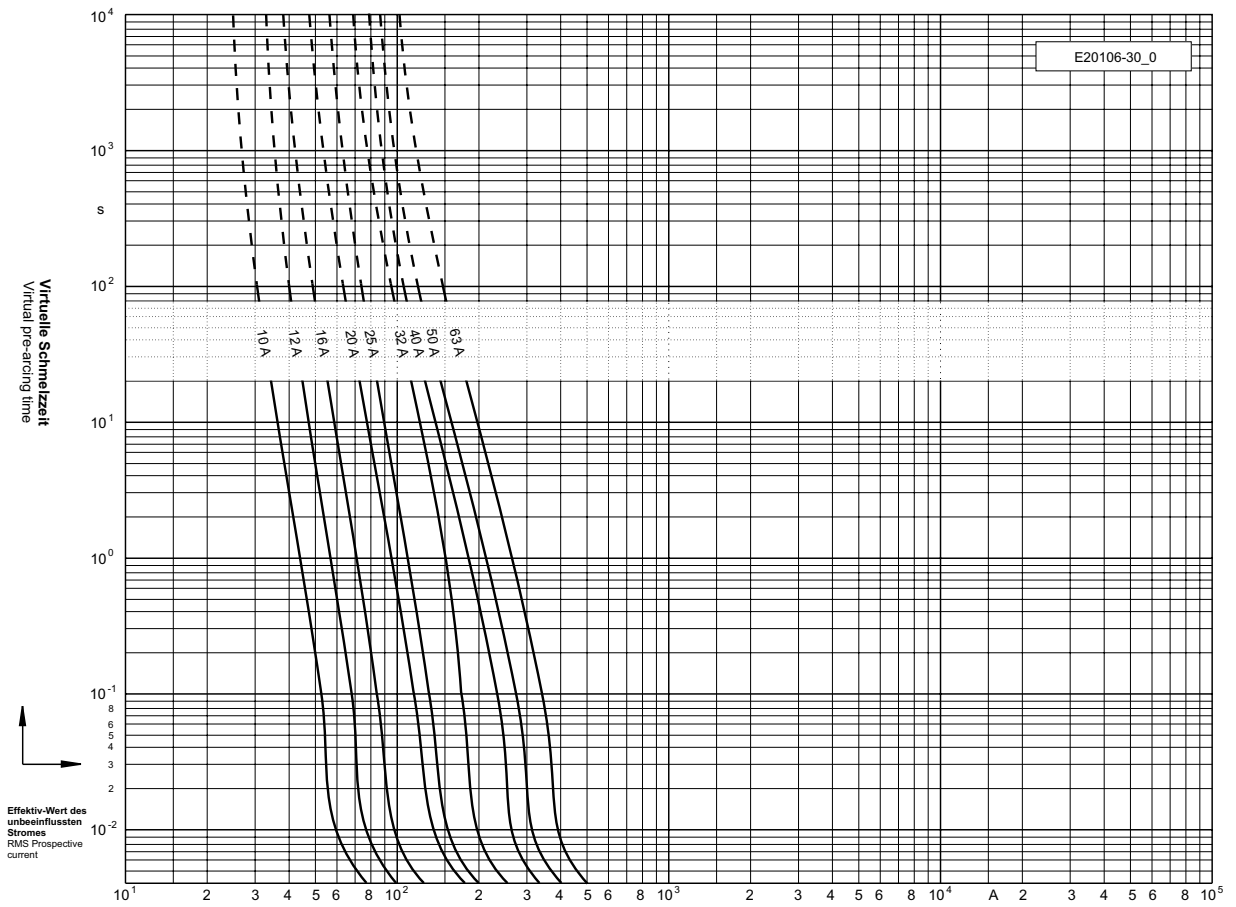

**DC-Anwendung**  
DC-Application

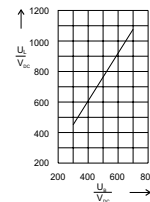

**Schaltspannungsdiagramm**  
Arc Voltage-Diagram

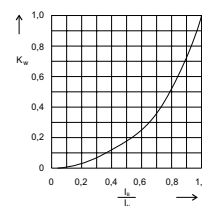

**Umrechnungsfaktor der Leistungsabgabe**  
Reduction factor for power Loss

**DC 720 V Ø 14 x 65 mm**

 usE180276

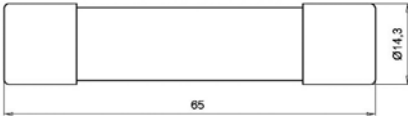

Verpackungseinheit / Packing unit: 10 Stück / 10 pieces

Betriebsklasse / Class <b>aR</b>	<b>UL 248-13</b>
-------------------------------------	------------------

Bemessungs- spannung Rated Voltage	Artikel Nr. Article No	Größe Size	Bemessungsstrom Rated Current
V			A
DC 720	50 206 06	Ø 14 x 65 mm	63

Bemessungsausschaltvermögen / Rated breaking capacity 30 kA (DC 720 V)

Bemessungsstrom Rated Current	Artikel Nr. Article No.	Gewicht Weight	Approbationen Approvals	Schmelzintegral Pre-Arcing I <sup>2</sup> t-Value	Ausschaltintegral Total I <sup>2</sup> t-Value @ DC 700 V	Leistungsabgabe Power Loss
A		kg / 1	UL rec.	A <sup>2</sup> s	A <sup>2</sup> s	W
63	50 206 06.63	0,03	*	512	4.200	11,4

Applikationskoeffizienten / Application coefficients (Weiterführende Informationen siehe Seite 13 / for more information see page 13)

a	A2	B1 max.	B2	Cf3
130	0,55	1,25	0,6	0,8

**DC 720 V**  $\varnothing 14 \times 65 \text{ mm}$

**RU** <sup>®</sup> usE180276

**Zeit/Strom-Kennlinien**  
Time-current characteristics

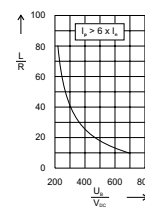
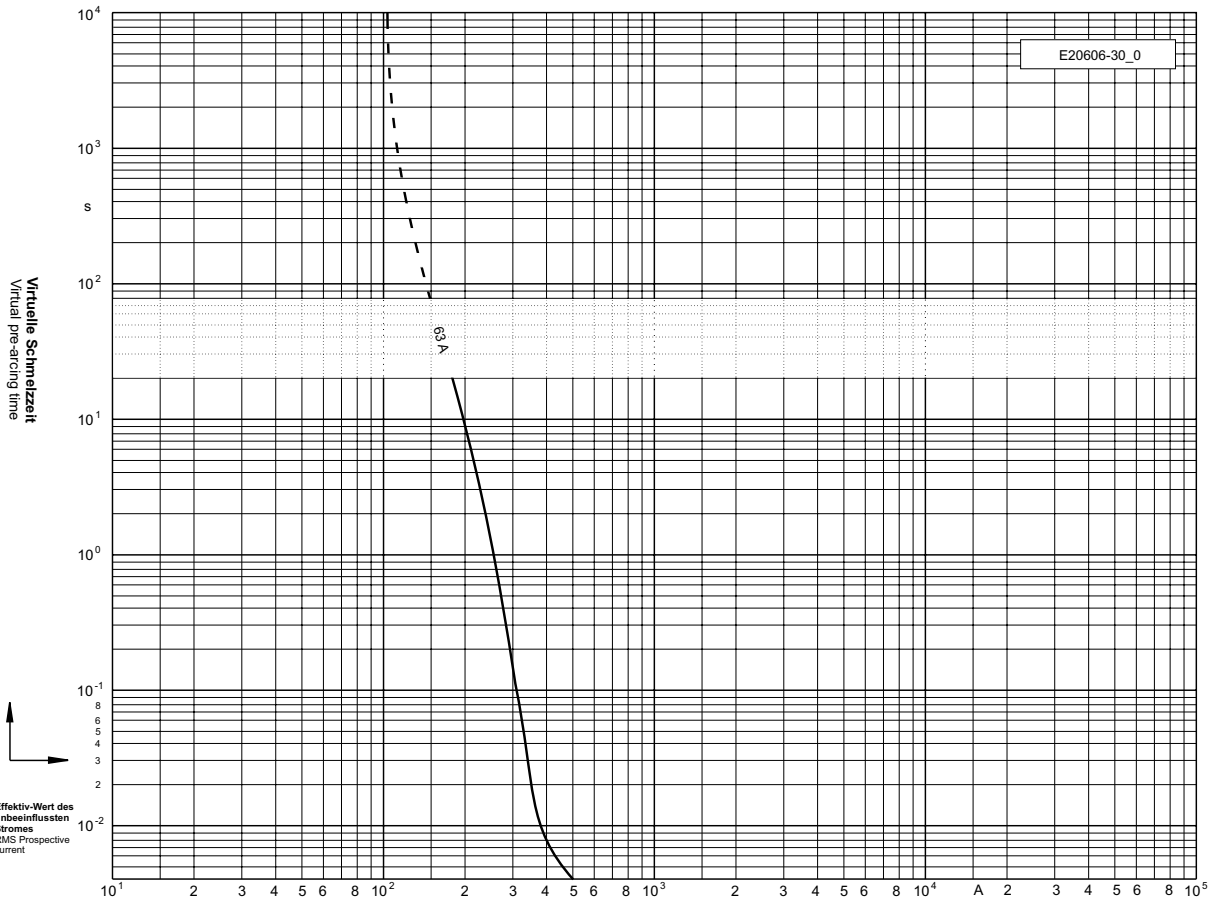

**DC-Anwendung**  
DC-Application

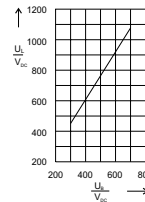

**Schaltspannungsdiagramm**  
Arc Voltage-Diagram

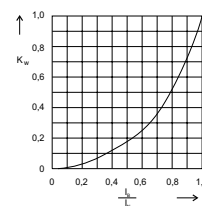

**Umrechnungsfaktor der Leistungsabgabe**  
Reduction factor for power loss

**DC 800 V Ø 14 x 51 mm**

 **usE180276**

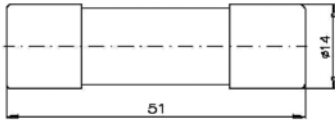

Verpackungseinheit / Packing unit: 10 Stück / 10 pieces

Betriebsklasse / Class <b>gR</b>	<b>UL 248-13</b>
-------------------------------------	------------------

Bemessungs- spannung Rated Voltage	Artikel Nr. Article No	Größe Size	Bemessungsstrom Rated Current
V			A
DC 800	50 120 06	Ø 14 x 51 mm	20-32

Bemessungsausschaltvermögen / Rated breaking capacity 10 kA (DC 800 V)

Bemessungsstrom Rated Current	Artikel Nr. Article No.	Gewicht Weight	Approbationen Approvals	Schmelzintegral Pre-Arcing I <sup>2</sup> t-Value	Ausschaltintegral Total I <sup>2</sup> t-Value @ DC 880 V	Leistungsabgabe Power Loss
A		kg / 1	UL rec.	A <sup>2</sup> s	A <sup>2</sup> s	W
20	50 120 06.20	0,02	*	46	370	3,2
25	50 120 06.25	0,02	*	90	715	4,0
32	50 120 06.32	0,02	*	120	950	5,5

Applikationskoeffizienten / Application coefficients (Weiterführende Informationen siehe Seite 13 / for more information see page 13)

a	A2	B1 max.	B2	Cf3
130	0,8	1,25	0,6	0,8



**DC 800 V Ø 14 x 51 mm**

**UL** cULusE180276

**Zeit/Strom-  
Kennlinien**  
Time-current  
characteristics

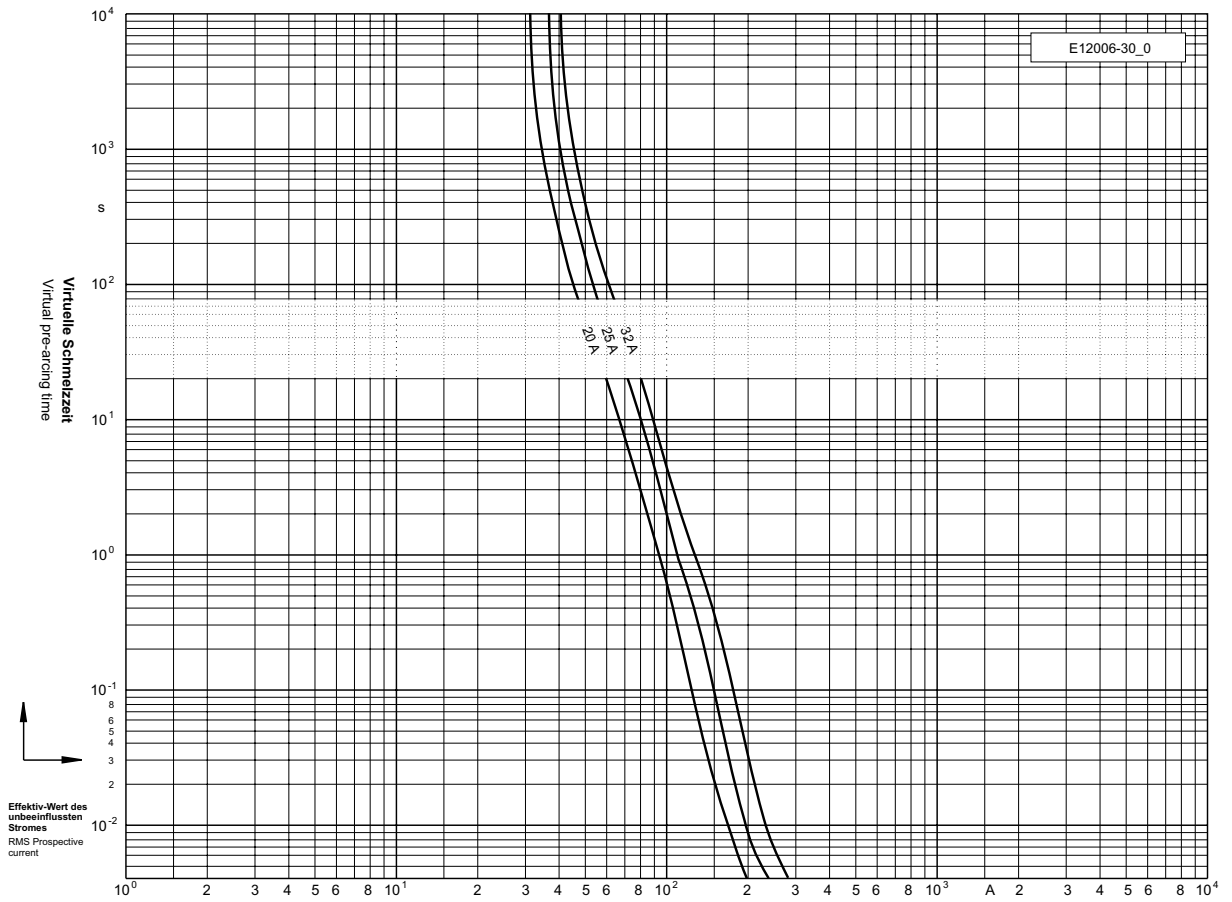

AC/DC 1000 V Ø 6,3 x 32 mm

 usE167295

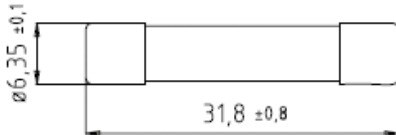

Verpackungseinheit / Packing unit: 10 Stück / 10 pieces

Charakteristik / Class <b>FF</b>	Werksnorm company standard
-------------------------------------	-------------------------------

Bemessungs- spannung Rated Voltage	Artikel Nr. Article No	Größe Size	Bemessungsstrom Rated Current
V			A
AC/DC 1000	70 172 40	6,3 x 32	0,100-2

Bemessungsausschaltvermögen / Rated breaking capacity 30 kA

Bemessungsstrom Rated Current	Artikel Nr. Article No.	Gewicht Weight	Be- messungs- spannung Rated Voltage	Spannungs- abfall Max. Voltage drop	Schmelz- integral Pre-Arcing- I <sup>2</sup> t-Value @ 10 x I <sub>N</sub>	Bemessungs-Ausschaltvermögen Rated breaking capacity		Leistungs- abgabe Power Loss
						AC	DC	
A		kg / 1	V	mV	A <sup>2</sup> s			W
0,100	70 172 40.0,1	0,002	AC/DC 1000	2.500	0.0009	30 kA @ 1000 V*	30 kA @ 1000 V*	0,3
0,125	70 172 40.0,125	0,002	AC/DC 1000	2.200	0.0017	30 kA @ 1000 V*	30 kA @ 1000 V*	0,3
0,160	70 172 40.0,16	0,002	AC/DC 1000	2.000	0.004	30 kA @ 1000 V*	30 kA @ 1000 V*	0,4
0,200	70 172 40.0,2	0,002	AC/DC 1000	900	0.01	30 kA @ 1000 V*	30 kA @ 1000 V*	0,2
0,250	70 172 40.0,25	0,002	AC/DC 1000	800	0.02	30 kA @ 1000 V*	30 kA @ 1000 V*	0,2
0,315	70 172 40.0,315	0,002	AC/DC 1000	700	0.04	30 kA @ 1000 V*	30 kA @ 1000 V*	0,3
0,400	70 172 40.0,4	0,002	AC/DC 1000	650	0.07	30 kA @ 1000 V*	30 kA @ 1000 V*	0,3
0,500	70 172 40.0,5	0,002	AC/DC 1000	650	0.12	30 kA @ 1000 V*	30 kA @ 1000 V*	0,4
0,630	70 172 40.0,63	0,002	AC/DC 1000	650	0.15	30 kA @ 1000 V	30 kA @ 1000 V	0,5
0,800	70 172 40.0,8	0,002	AC/DC 1000	600	0.23	30 kA @ 1000 V	30 kA @ 1000 V	0,5
1	70 172 40.1	0,002	AC/DC 1000	750	0.32	30 kA @ 1000 V	30 kA @ 1000 V	0,8
1,6	70 172 40.1,6	0,002	AC/DC 1000	650	0.31	30 kA @ 1000 V	30 kA @ 1000 V	1,1
2	70 172 40.2	0,002	AC/DC 1000	650	0.64		30 kA @ 1000 V	1,4

\* Zusätzlicher Bemessungs-Ausschaltvermögen: 50 kA @ 1000 V AC/DC  
Additional rated breaking capacity: 50 kA @ 1000 V AC/DC

Applikationskoeffizienten / Application coefficients (Weiterführende Informationen siehe Seite 13 / for more information see page 13)

a	A2	B1 max.	B2	Cf3
130	0,8	1,25	0,8	0,8

**AC/DC 1000 V Ø 6,3 x 32 mm**

**usE167295**

**Zeit/Strom-  
Kennlinien**  
Time-current  
characteristics

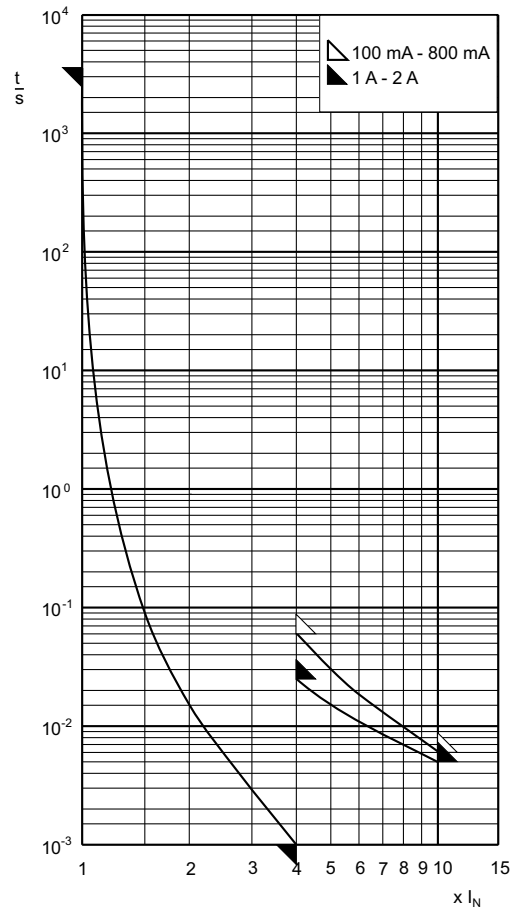

**AC/DC 1000 V Ø 10 x 35 mm**

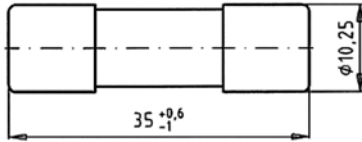

Verpackungseinheit / Packing unit: 10 Stück / 10 pieces

Betriebsklasse / Class <b>aR</b>	Werksnorm company standard
-------------------------------------	-------------------------------

Bemessungs- spannung Rated Voltage	Artikel Nr. Article No	Größe Size	Bemessungsstrom Rated Current
V			mA
AC/DC 1000	50 210 06	Ø 10 x 35 mm	440

Bemessungsausschaltvermögen / Rated breaking capacity **30 kA**

Bemessungsstrom Rated Current	Artikel Nr. Article No.	Gewicht Weight	Bemessungs- spannung Rated Voltage	Schmelz- integral Pre-Arcing- I <sup>2</sup> t-Value	Ausschalt- integral Total I <sup>2</sup> t-Value @AC 1000 V	Ausschalt- integral Total I <sup>2</sup> t-Value @DC 1000 V	Leistungs- abgabe Power Loss @ 1,0 x I <sub>rat</sub>	Widerstand bei 20°C Resistant @20°C
mA		kg / 1	V	A <sup>2</sup> s	A <sup>2</sup> s	A <sup>2</sup> s	W	mΩ
440	50 210 06.0,44	0,01	1000	0,17	1,2	1	0,2	980

Applikationskoeffizienten / Application coefficients (Weiterführende Informationen siehe Seite 13 / for more information see page 13)

a	A2	B1 max.	B2	Cf3
150	0,6	1,25	0,6	0,8

**AC/DC 1000 V Ø 10 x 35 mm**

**Zeit/Strom-  
Kennlinien**  
Time-current  
characteristics

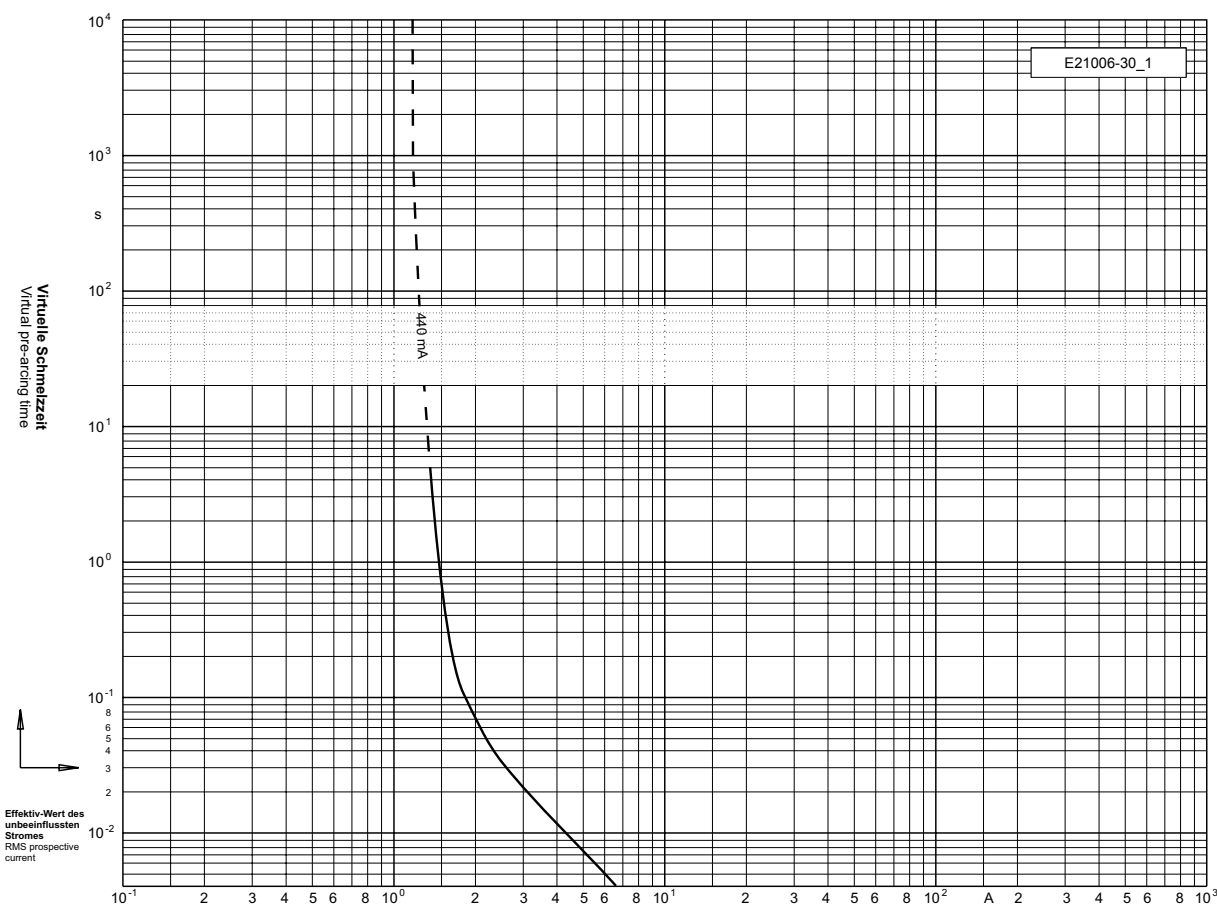

**AC/DC 1000 V Ø 10 x 38 mm**

 **usE180276**

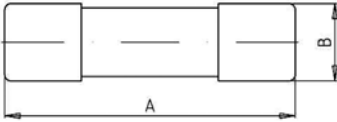

**Verpackungseinheit / Packing unit:** 10 Stück / 10 pieces

Betriebsklasse / Class <b>gR</b>	<b>UL 248-13</b>
-------------------------------------	------------------

Bemessungs- spannung Rated Voltage	Artikel Nr. Article No	Größe Size	Bemessungsstrom Rated Current
V			A
AC/DC 1000	50 199 06	Ø 10 x 38 mm	0,5-16

**Bemessungsausschaltvermögen / Rated breaking capacity** 30 kA L/R = 1 ms

Bemessungsstrom Rated Current	Artikel Nr. Article No.	Gewicht Weight	Bemessungs- spannung Rated Voltage	Bemessungs- ausschalt- vermögen Rated breaking capacity @AC/DC 1000 V	Schmelzintegral Pre-Arcing- I <sup>2</sup> t-Value	Ausschaltintegral Total I <sup>2</sup> t-Value @ DC 1000 V L/R=5ms	Leistungsabgabe Power Loss
A		kg / 1	V	kA	A <sup>2</sup> s	A <sup>2</sup> s	W
0,5	50 199 06.0,5	0,01	1000	30	0,2	2,2	0,2
1	50 199 06.1	0,01	1000	30	0,45	2	0,3
2	50 199 06.2	0,01	1000	30	1,2	3	0,9
3,5	50 199 06.3,5	0,01	1000	30	5	27	1,8
4	50 199 06.4	0,01	1000	30	3	25	0,5
6	50 199 06.6	0,01	1000	30	5	40	0,7
8	50 199 06.8	0,01	1000	30	7	55	1,1
10	50 199 06.10	0,01	1000	30	10	77	1,5
11	50 199 06.11	0,01	1000	30	17	130	1,6
12	50 199 06.12	0,01	1000	30	20	155	1,6
15	50 199 06.15	0,01	1000	30	30	230	1,8
16	50 199 06.16	0,01	1000	30	30	230	2,1

Applikationskoeffizienten / Application coefficients (Weiterführende Informationen siehe Seite 13 / for more information see page 13)

a	A2	B1 max.	B2	CF3
150	0,6	1,25	0,5	0,8

AC/DC 1000 V Ø 10 x 38 mm

cULus E180276

Zeit/Strom-  
Kennlinien  
Time-current  
characteristics

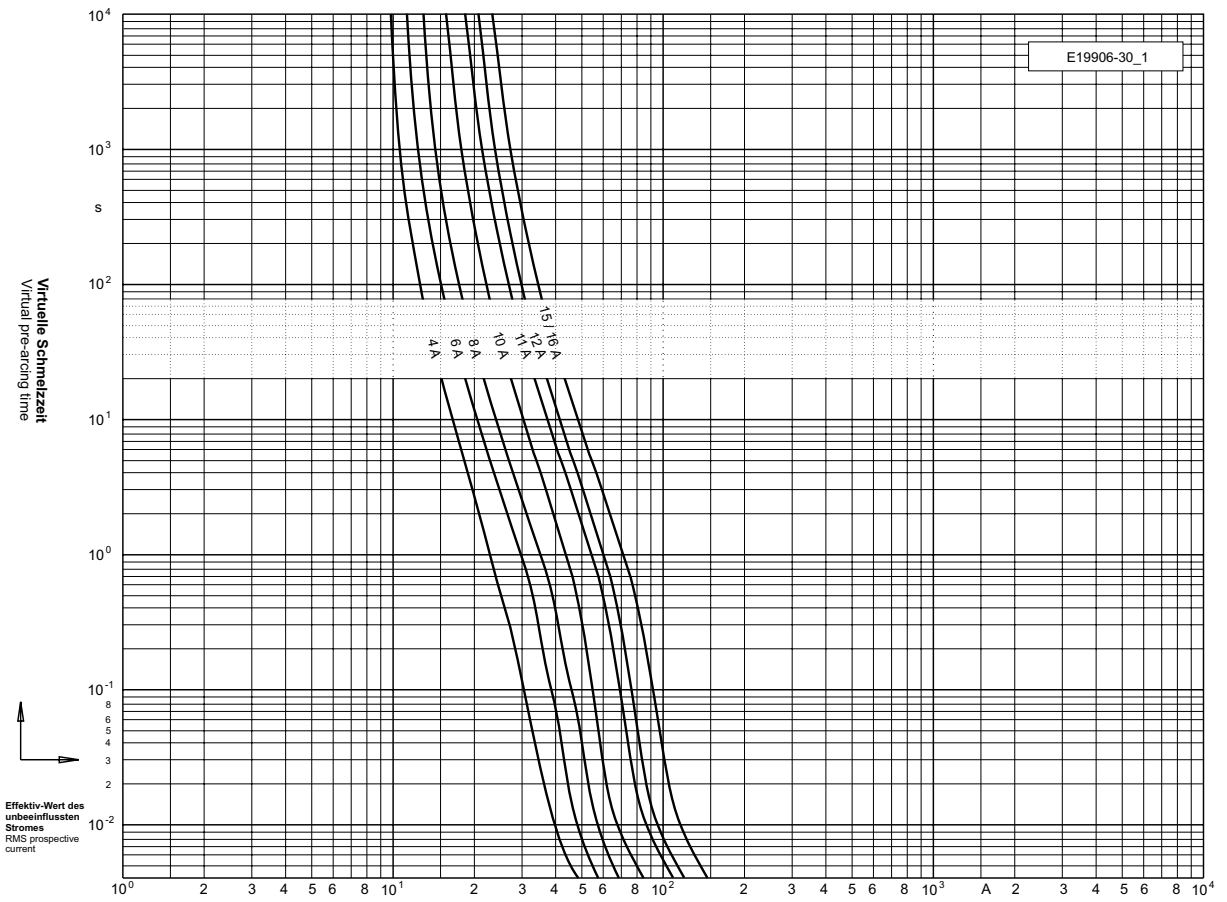

**DC 1000 V Ø 14 x 51 mm**

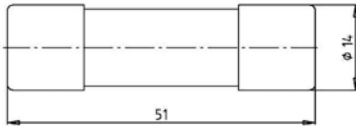

50 204 26

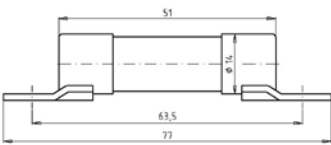

50 205 26

Verpackungseinheit / Packing unit: 10 Stück / 10 pieces

Betriebsklasse / Class <b>gPV</b>	<b>IEC 60269-6</b>
--------------------------------------	--------------------

Bemessungs- spannung Rated Voltage	Artikel Nr. Article No	Größe Size	Bemessungsstrom Rated Current
V			A
DC 1000	50 204 26	Ø 14 x 51 mm	10-32
	50 205 26		

Bemessungsausschaltvermögen / Rated breaking capacity **30 kA L/R = 1-3 ms**

Bemessungs- strom Rated Current	Artikel Nr. Article No.		Gewicht Weight	Bemessungs- spannung Rated Voltage	Schmelz- integral Pre-Arcing- I <sup>2</sup> t-Value	Ausschalt- integral Total I <sup>2</sup> t-Value @ breaking test Voltage	Leistungs- abgabe Power Loss
A			kg / 1	V	A <sup>2</sup> s	A <sup>2</sup> s	W
10	50 204 26.10	50 205 26.10	0,02	1000	5	40	2,9
12	50 204 26.12	50 205 26.12	0,02	1000	12	100	3,0
20	50 204 26.20	50 205 26.20	0,02	1000	52	330	4,0
25	50 204 26.25	50 205 26.25	0,02	1000	82	510	5,1
32	50 204 26.32	50 205 26.32	0,02	1000	150	950	6,0

Applikationskoeffizienten / Application coefficients (Weiterführende Informationen siehe Seite 13 / for more information see page 13)

a	A2	B1 max.	B2	CF3
130	0,9	1,25	0,5	0,8



**DC 1000 V Ø 14 x 51 mm**

**Zeit/Strom-  
Kennlinien**  
Time-current  
characteristics

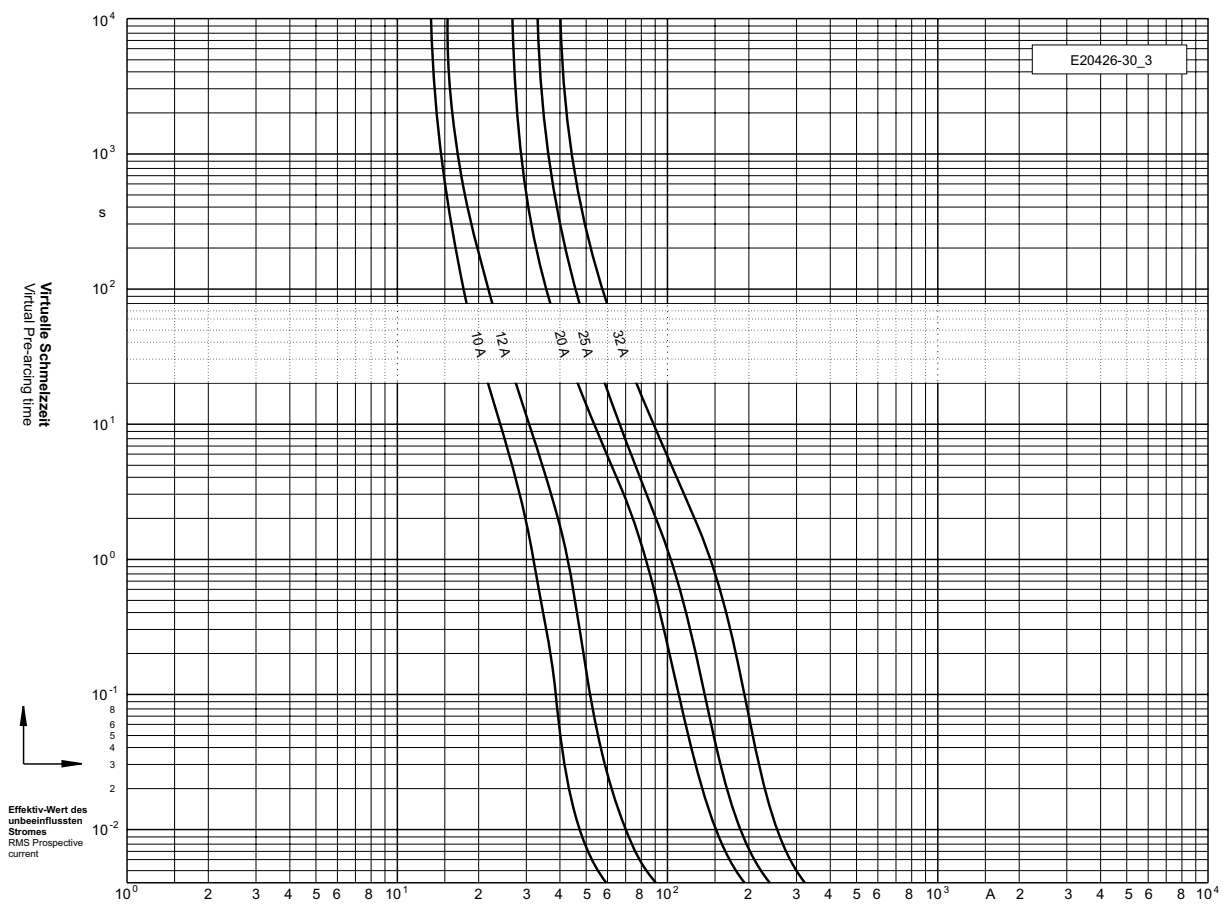

**DC 1000 V Ø 10 x 38 mm**

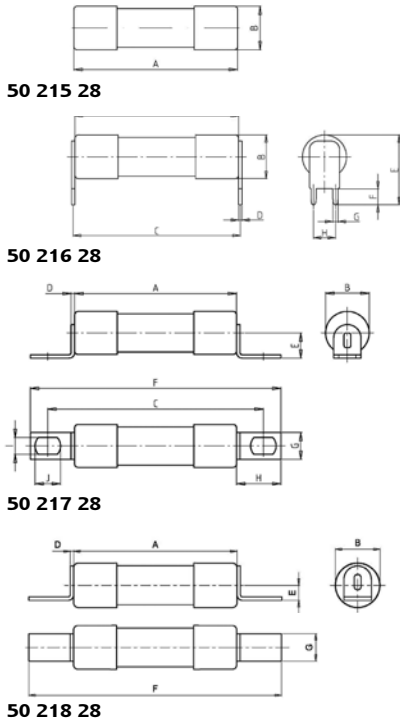

Verpackungseinheit / Packing unit: 10 Stück / 10 pieces

Betriebsklasse / Class <b>gPV</b>	<b>IEC 60 269-6</b> <b>UL 2579</b>
--------------------------------------	---------------------------------------

Bemessungs- spannung Rated Voltage	Artikel Nr. Article No	
V		
DC 1000	50 215 28	
	50 216 28	mit Einlötpins with soldering contacts
	50 217 28	mit Anschraub- laschen with bolted contacts
	50 218 28	für Kabelmontage for cable connection

Bemessungsausschaltvermögen / Rated breaking capacity 30 kA DC 1000 V  
L/R = 1-3 ms

Bemessungs- strom Rated Current	Artikel Nr. Article No.				Gewicht Weight	Bemes- sungsspan- nung Rated Voltage	Bemes- sungsspan- nung Rated Voltage	Schmelz- integral Pre-Arcing- I <sup>2</sup> t-Value	Leistungs- abgabe Power Loss
		mit Einlötpins with soldering contacts	mit Anschraub- laschen with bolted contacts	für Kabel- montage for cable connections					
A					kg / 1	V	V	A <sup>2</sup> s	W
3,5				50 218 28.3,5	0,01	DC 1000	DC 1000	0,33	0,8
4				50 218 28.4	0,01	DC 1000	DC 1000	10	1,8
5				50 218 28.5	0,01	DC 1000	DC 1000	20	2,0
8	50 215 28.8	50 216 28.8	50 217 28.8	50 218 28.8	0,01	DC 1000	DC 1000	3	1,9
10	50 215 28.10	50 216 28.10	50 217 28.10	50 218 28.10	0,01	DC 1000	DC 1000	5	2,3
12	50 215 28.12	50 216 28.12	50 217 28.12	50 218 28.12	0,01	DC 1000	DC 1000	9	2,9
15	50 215 28.15	50 216 28.15	50 217 28.15	50 218 28.15	0,01	DC 1000	DC 1000	17	3,3
16	50 215 28.16	50 216 28.16	50 217 28.16	50 218 28.16	0,01	DC 1000	DC 1000	20	3,4
20	50 215 28.20	50 216 28.20	50 217 28.20	50 218 28.20	0,01	DC 1000	DC 1000	40	3,9
22,4	50 215 28.22,4	50 216 28.22,4	50 217 28.22,4	50 218 28.22,4	0,01	DC 1000	DC 1000	52	4,5

Applikationskoeffizienten / Application coefficients (Weiterführende Informationen siehe Seite 13 / for more information see page 13)

a	A2	B1 max.	B2	CF3
130	0,8	1,25	0,5	0,8

**DC 1000 V Ø 10 x 38 mm** 

**Zeit/Strom-Kennlinien**  
Time-current characteristics

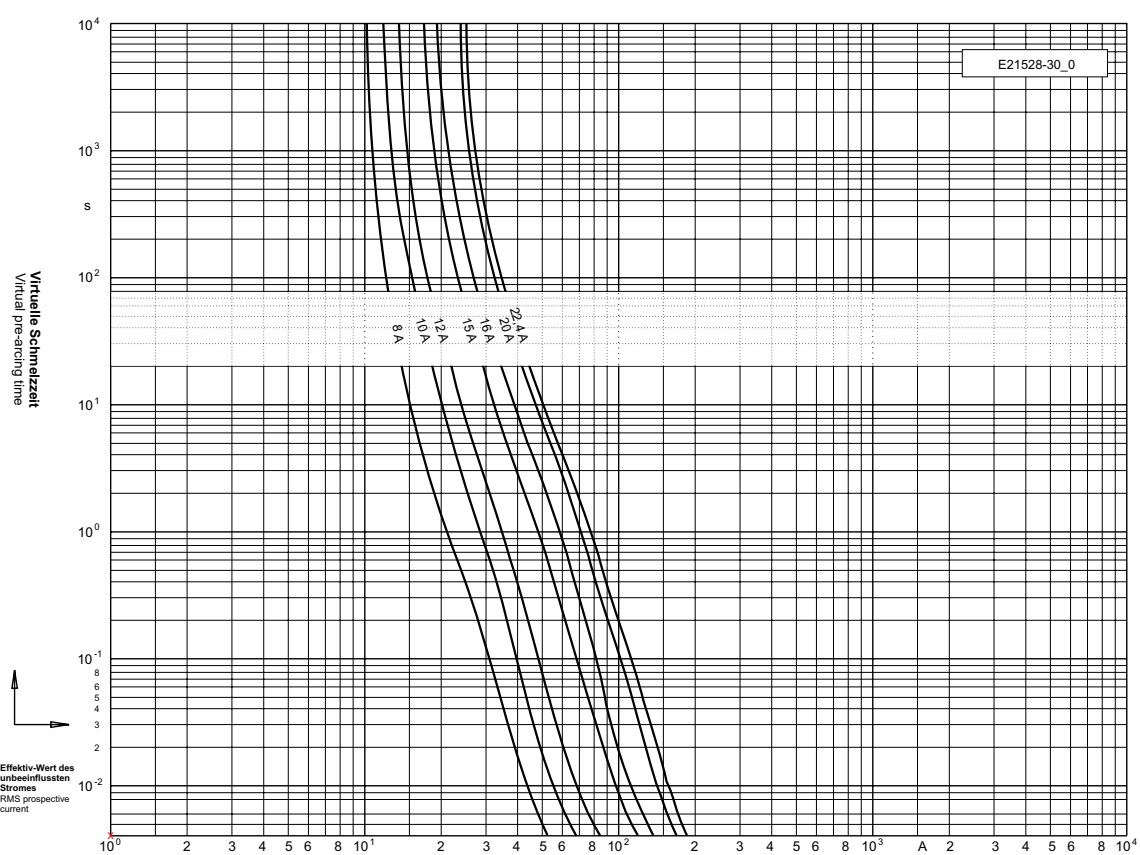
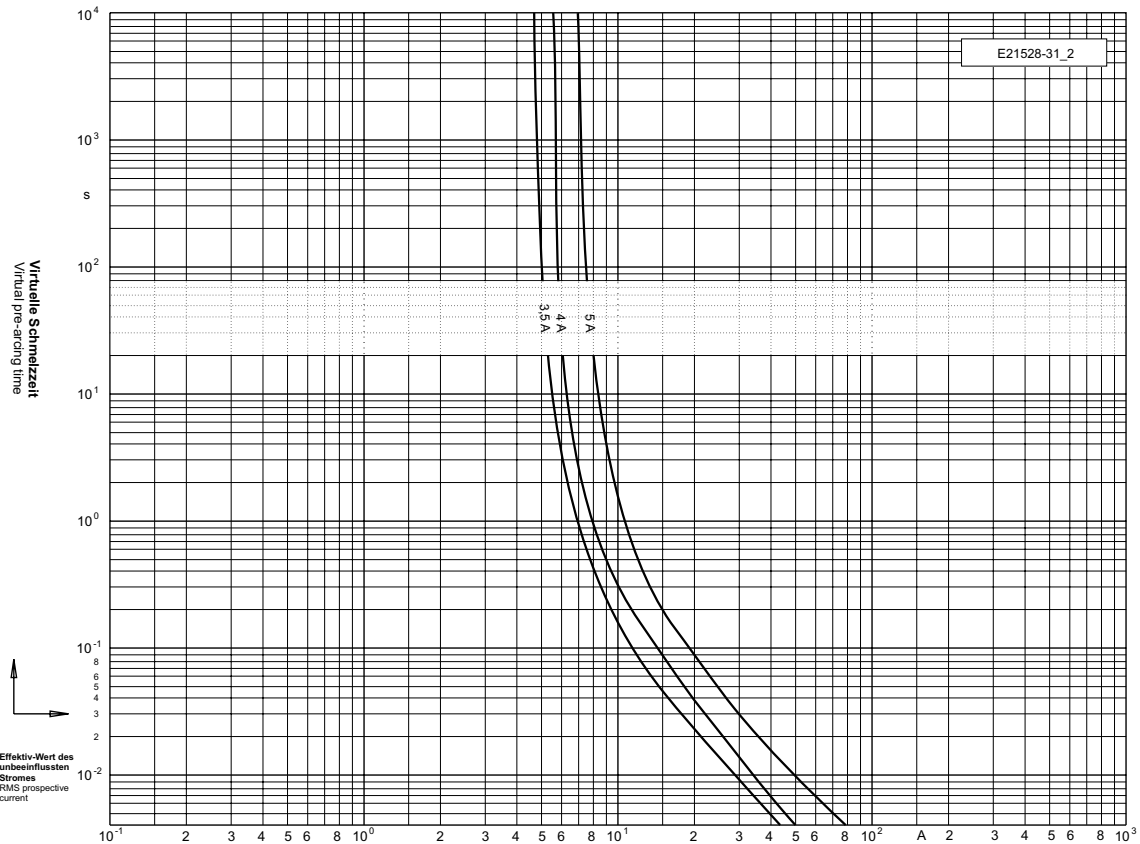

**DC 1000 V Ø 24 x 150 mm**

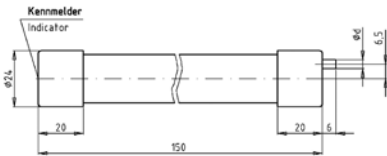

Verpackungseinheit / Packing unit: 1 Stück / 1 pieces

Charakteristik / Class <b>F flink</b>
--

Bemessungsspannung Rated Voltage	Artikel Nr. Article No	Größe Size	Bemessungsstrom Rated Current
V			A
DC 1000	90 078 10	Ø 24 x 150 mm	6,3-20

Bemessungsausschaltvermögen / Rated breaking capacity **10 kA**

Bemessungsstrom Rated Current	Artikel Nr. Article No.	Gewicht Weight	Kennmelderfarbe Indicator colour	Durchmesser Ø	Schmelzintegral Pre-Arcing-I <sup>2</sup> t-Value	Ausschaltintegral Total I <sup>2</sup> t-Value @ DC 1200 V	Leistungsabgabe Power Loss
A		kg / 1			A <sup>2</sup> s	A <sup>2</sup> s	W
6,3	90 078 10.6,3	0,15	grün / green	-	20	80	2,4
10	90 078 10.10	0,15	rot / red	4	32	130	5,1
16	90 078 10.16	0,15 0,15	grau / grey	6	220	880	5,2
20	90 078 10.20		blau / blue	8	330	1.400	6,1

Applikationskoeffizienten / Application coefficients (Weiterführende Informationen siehe Seite 13 / for more information see page 13)

a	A2	B1 max.	B2	Cf3
130	0,9	1,25	0,5	0,8

**DC 1000 V Ø 24 x 150 mm**

**Zeit/Strom-Kennlinien**  
Time-current characteristics

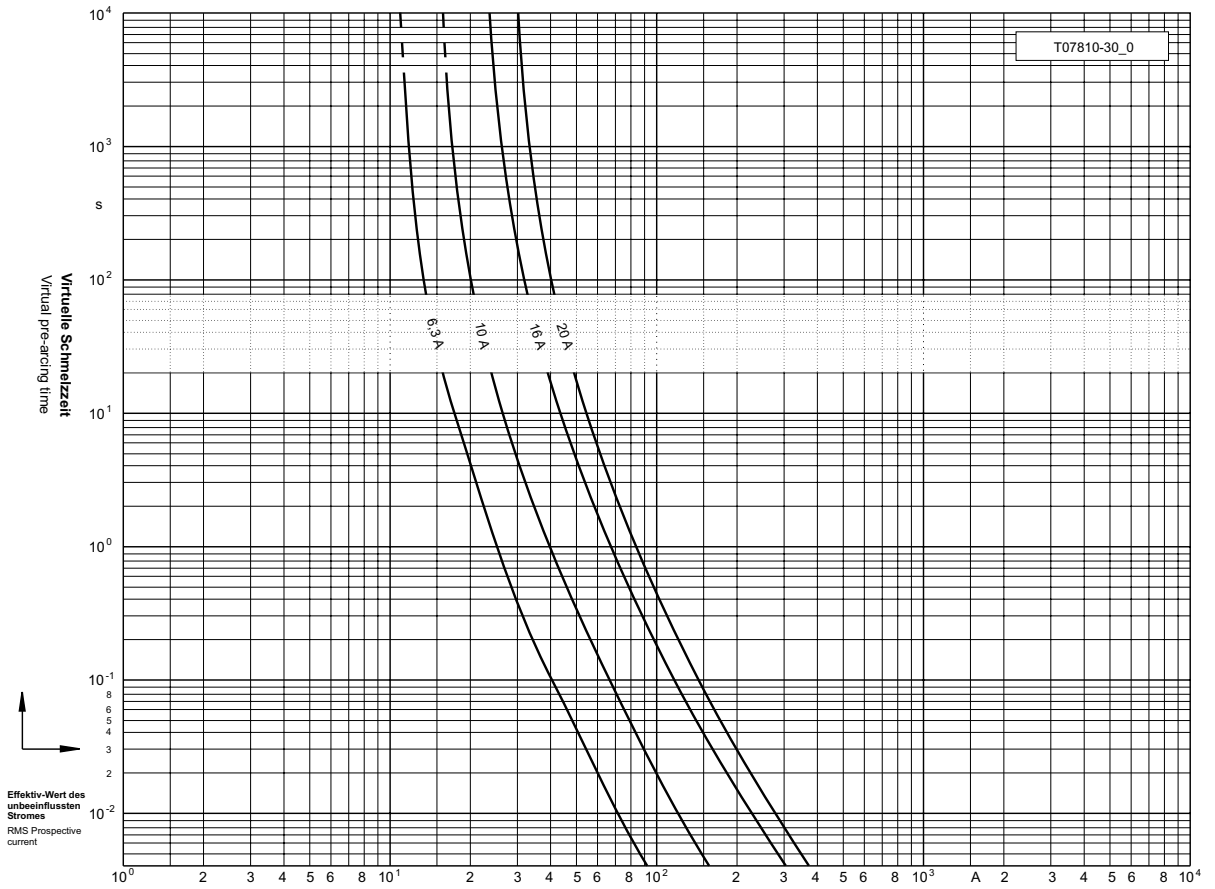

**Durchlass-Strom**  
Cut-off current

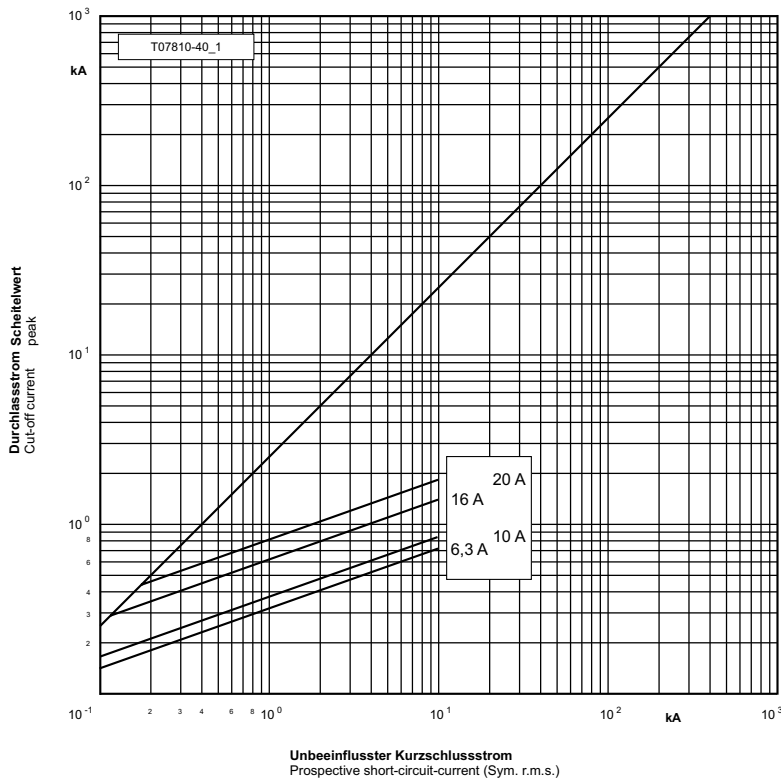

**DC 1000 V Ø 34,5 x 195 mm**

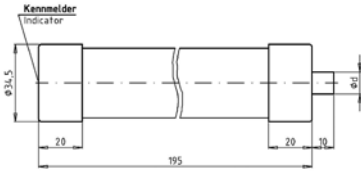

Verpackungseinheit / Packing unit: 1 Stück / 1 pieces

Charakteristik / Class <b>F</b> flink	Werksnorm company standard
---	-------------------------------

Bemessungsspannung Rated Voltage	Artikel Nr. Article No	Größe Size	Bemessungsstrom Rated Current
V			A
DC 1000	90 077 10	Ø 34,5 x 195 mm	10-60

Bemessungsausschaltvermögen / Rated breaking capacity 10 kA

Bemessungsstrom Rated Current	Artikel Nr. Article No.	Gewicht Weight	Kennmelderfarbe Indicator colour	Durchmesser Ø	Schmelzintegral Pre-Arcing- I <sup>2</sup> t-Value	Ausschaltintegral Total I <sup>2</sup> t-Value @ DC 1000 V	Leistungsabgabe Power Loss
A		kg / 1			A <sup>2</sup> s	A <sup>2</sup> s	W
10	90 077 10.10	0,50	rot / red	6	30	130	6,8
25	90 077 10.25	0,50	gelb / yellow	10	1.100	4.300	9,3
35	90 077 10.35	0,50	schwarz / black	13	1.500	5.900	9,5
50	90 077 10.50	0,50	weiß / white	16	4.100	16.200	12
60	90 077 10.60	0,50	kupfer / copper	19	5.200	20.800	15

Applikationskoeffizienten / Application coefficients (Weiterführende Informationen siehe Seite 13 / for more information see page 13)

a	A2	B1 max.	B2	CF3
130	0,9	1,25	0,5	0,8

**DC 1000 V Ø 34,5 x 195 mm**

**Zeit/Strom-  
Kennlinien**  
Time-current  
characteristics

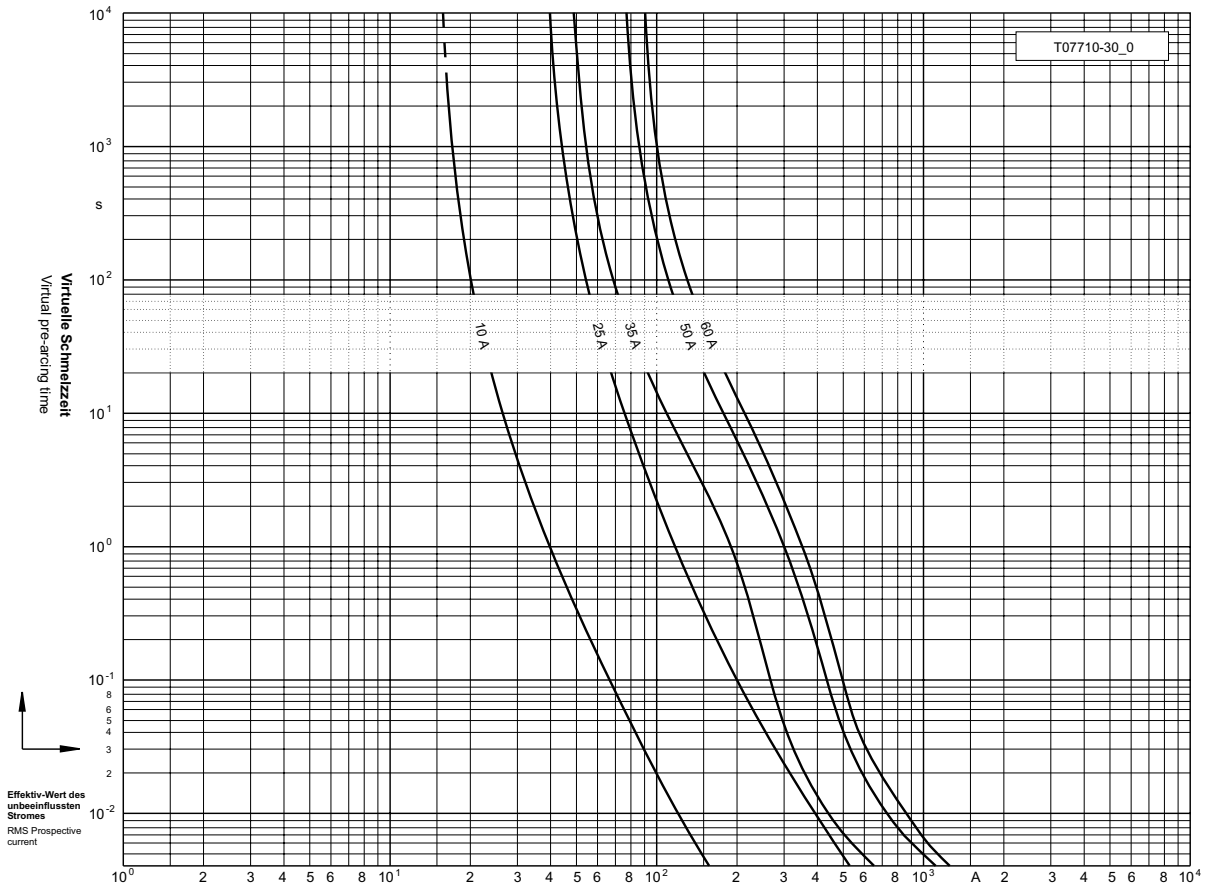

**Durchlass-Strom**  
Cut-off current

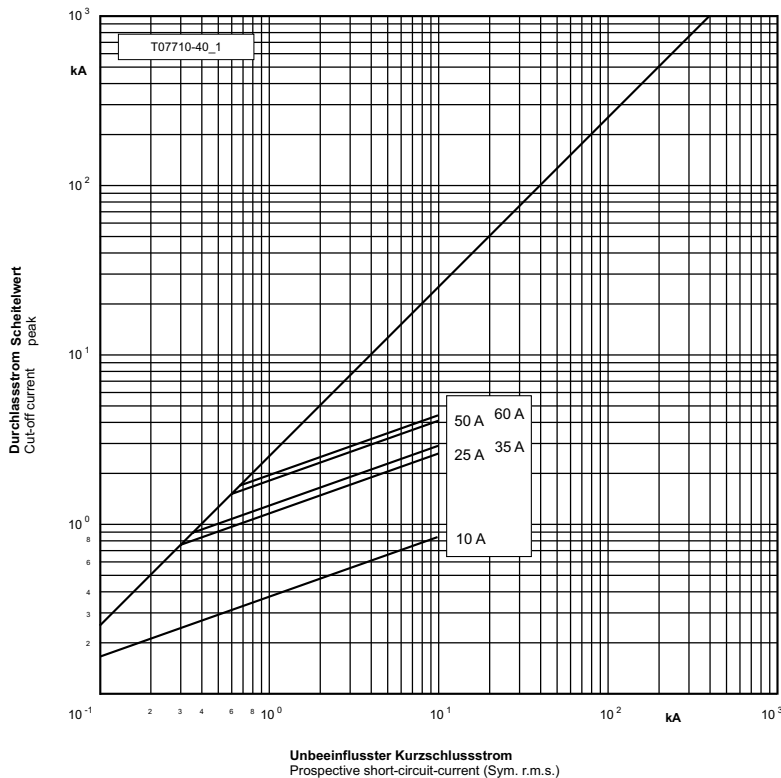

**DC 1000 V Ø 20 x 127 mm**

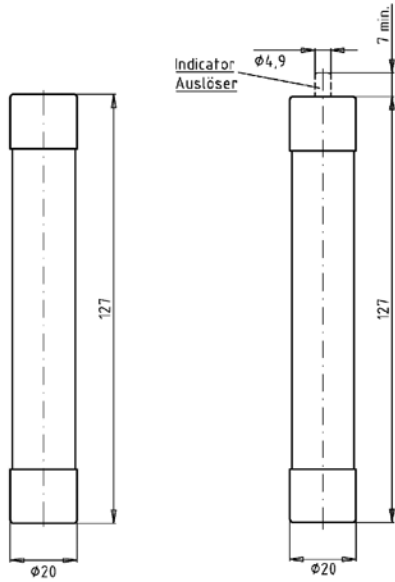

90 080 10

90 082 10

Verpackungseinheit / Packing unit: 12 Stück / 12 pieces

Betriebsklasse / Class <b>aR</b> <b>gR</b>	<b>EN IEC 60 269-4</b> <b>DIN VDE 0636-40</b>
--	--

Bemessungs- spannung Rated Voltage	Artikel Nr. Article No	Größe Size	Bemessungsstrom ohne Kennmelder Rated Current without indicator	Bemessungsstrom mit Kennmelder Rated Current with indicator
V			A	A
DC 1000	90 080 10	20 x 127 mm	< 6	6-63

Bemessungs- spannung Rated Voltage	Artikel Nr. Article No	Größe Size	Bemessungsstrom mit Auslöser Rated Current with striker pinr
V			A
DC 1000	90 082 10	20 x 127 mm	6-63

**Bemessungsausschaltvermögen / Rated breaking capacity 30 kA**

Bemessungsstrom Rated Current	Artikel Nr. Article No.		Gewicht Weight	Betriebsklasse Operating class	Schmelzintegral Pre-Arcing- I <sup>2</sup> t-Value	Ausschalt- integral Total I <sup>2</sup> t-Value	Leistungsabgabe Power Loss
A	Kennmelder	Striker 2,5 N	kg / 1		A <sup>2</sup> s	A <sup>2</sup> s	W
						@ DC 1000 V	
3,15	90 080 10.3,15		0,10	aR	2	13	4,1
6	90 080 10.6	90 082 10.6	0,10	gR	3	17	3,0
8	90 080 10.8	90 082 10.8	0,10	gR	7	42	3,2
10	90 080 10.10	90 082 10.10	0,10	gR	13	75	3,4
12	90 080 10.12	90 082 10.12	0,10	gR	20	120	4,6
16	90 080 10.16	90 082 10.16	0,10	gR	52	300	5,7
20	90 080 10.20	90 082 10.20	0,10	gR	82	470	6,8
25	90 080 10.25	90 082 10.25	0,10	gR	118	670	8,1
32	90 080 10.32	90 082 10.32	0,10	gR	184	1.050	10
40	90 080 10.40	90 082 10.40	0,10	gR	472	2.700	12
50	90 080 10.50	90 082 10.50	0,10	gR	737	4.200	13
63	90 080 10.63	90 082 10.63	0,10	gR	1.300	7.500	18

Applikationskoeffizienten / Application coefficients (Weiterführende Informationen siehe Seite 13 / for more information see page 13)

a	A2	B1 max.	B2	Cf3
130	0,6	1,25	0,6	0,8



**DC 1000 V Ø 20 x 127 mm**

**Zeit/Strom-Kennlinien**  
Time-current characteristics

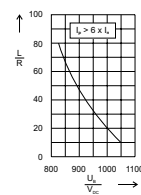
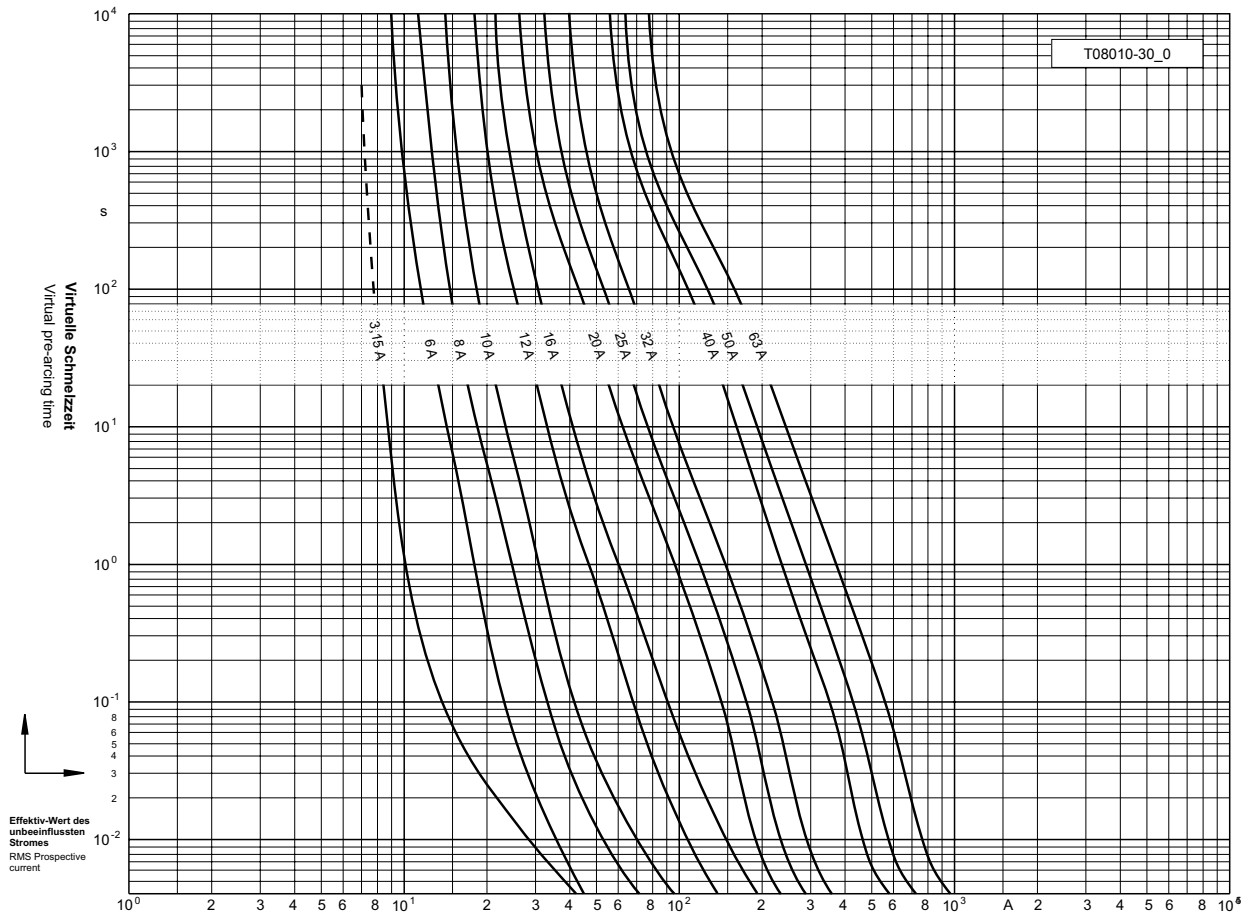

**Umrechnungsfaktor für den Ausschalt  $i^2t$ -Wert**  
Reduction factor for total  $i^2t$ -value

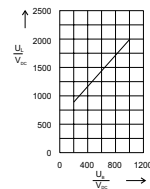

**Schaltspannungsdiagramm**  
Arc Voltage-Diagram

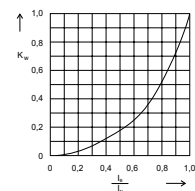

**Umrechnungsfaktor der Leistungsabgabe**  
Reduction factor for power Loss

**DC 1000 V Ø 36 x 127 mm**

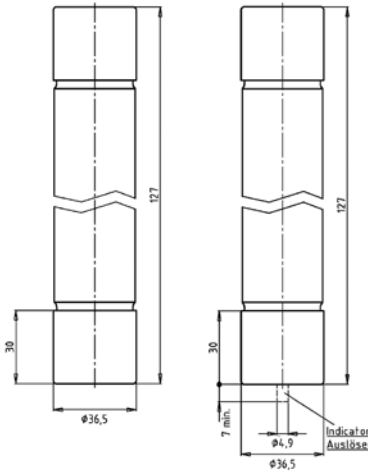

90 092 10

90 093 10

Verpackungseinheit / Packing unit: 3 Stück / 3 pieces

Betriebsklasse / Class <b>gR</b>	in Anlehnung an / in compliance with: <b>VDE 0636-1 und -4</b>
-------------------------------------	---

Bemessungs- spannung Rated Voltage	Artikel Nr. Article No	Größe Size	Bemessungs- strom Rated Current	Länge L Length L	Durchmesser D Diameter D
V			A	mm	mm
DC 1000	90 092 10	36 x 127	20-100	127	36,5
	90 093 10		20-100	127	36,5

Bemessungsausschaltvermögen / Rated breaking capacity 30 kA (L/R = 15ms)

Bemessungsstrom Rated Current	Artikel Nr. Article No.		Gewicht Weight	Schmelzintegral Pre-Arcing- I <sup>2</sup> t-Value	Ausschaltintegral Total I <sup>2</sup> t-Value @ DC 1000 V L/R=10 ms	Leistungsabgabe * Power Loss
	Ohne Auslöser/ without striker	Mit Auslöser/ with striker				
A			kg / 1	A <sup>2</sup> s	A <sup>2</sup> s	W
20	90 092 10.20	90 093 10.20	0,39	63	540	6
25	90 092 10.25	90 093 10.25	0,39	104	850	7
32	90 092 10.32	90 093 10.32	0,39	180	1.550	8
40	90 092 10.40	90 093 10.40	0,39	415	3.600	9
50	90 092 10.50	90 093 10.50	0,39	740	6.500	13
63	90 092 10.63	90 093 10.63	0,39	1.000	8.800	17
80	90 092 10.80	90 093 10.80	0,39	2.050	18.300	20
100	90 092 10.100	90 093 10.100	0,39	3.500	31.500	26

Applikationskoeffizienten / Application coefficients (Weiterführende Informationen siehe Seite 13 / for more information see page 13)

a	A2	B1 max.	B2	Cf3
130	0,6	1,25	0,6	0,8

**DC 1000 V Ø 36 x 127 mm**

**Zeit/Strom-  
Kennlinien**  
Time-current  
characteristics

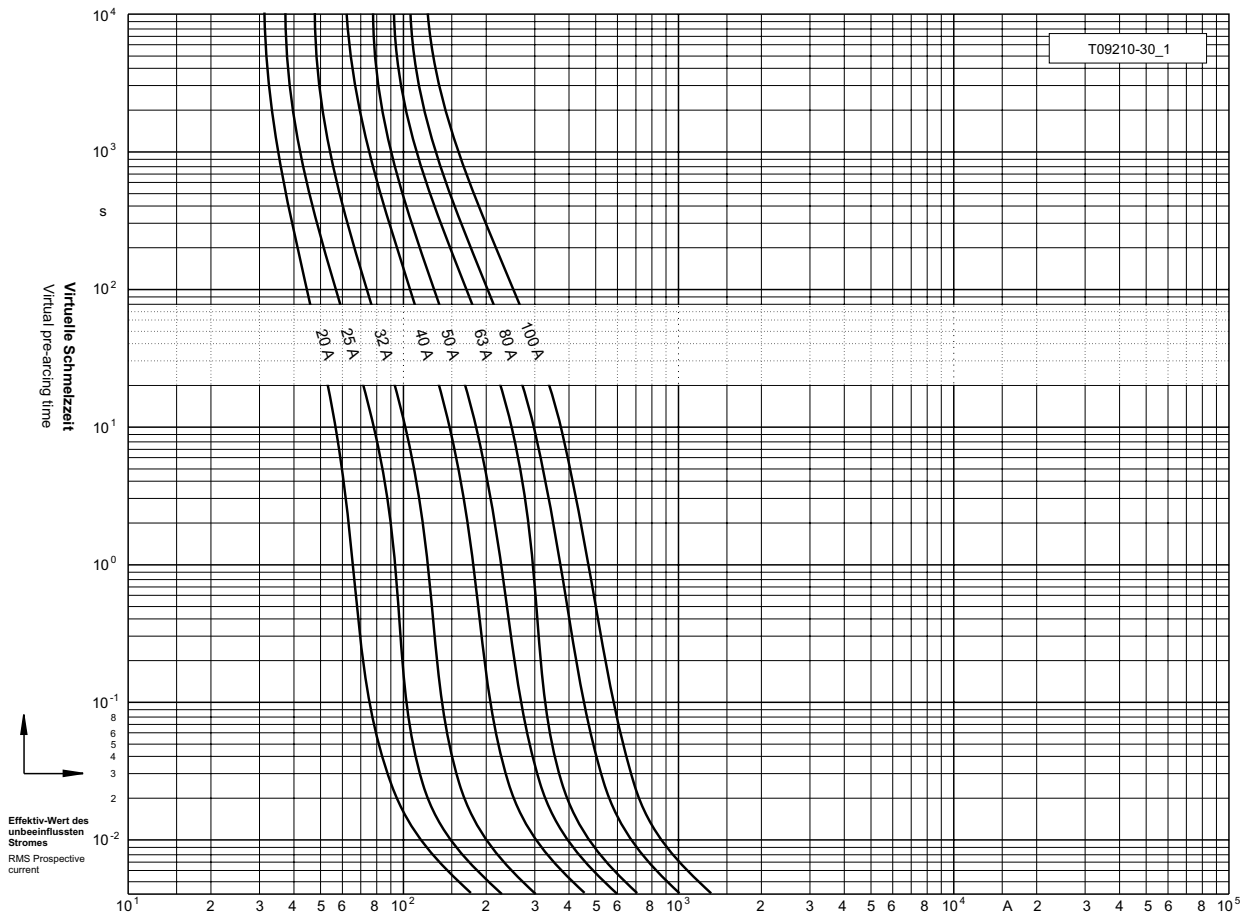

**DC 1100 V Ø 14 x 65 mm**



50 235 26

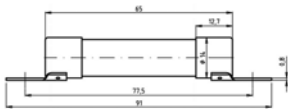

50 237 26



50 238 26

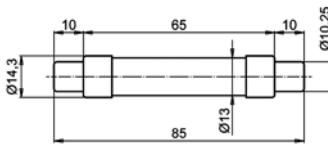

50 239 26

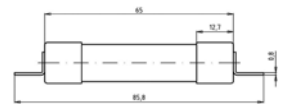

Verpackungseinheit / Packing unit: 10 Stück / 10 pieces

Betriebsklasse / Class <b>gPV</b>	<b>IEC 60 269-6</b>	<b>Entwurf Stand 2009 proposal issued 2009</b>
--------------------------------------	---------------------	--

Bemessungs- spannung Rated Voltage	Artikel Nr. Article No	
V		
DC 1100	50 235 26	14 x 65 mm
	50 237 26	mit Anschraub- laschen with bolted contacts
	50 238 26	10/14 x 85
	50 239 26	mit Anschraub- laschen with bolted contacts

**Bemessungsausschaltvermögen / Rated breaking capacity 30 kA DC 1100 V**  
L/R = 1 ms

Bemessungs- strom Rated Current	Artikel Nr. Article No.				Gewicht Weight	Be- messungs- spannung Rated Voltage	Schmelz- integral Pre-Arcing- I <sup>2</sup> t-Value	Ausschalt- integral Total I <sup>2</sup> t-Value	Leistungs- abgabe Power Loss
		mit Anschraub- laschen with bolted contacts		für Kabel- montage for cable connection					
A					kg / 1	V	A <sup>2</sup> s	A <sup>2</sup> s	W
8	50 235 26.8	50 237 26.8	50 238 26.8	50 239 26.8	0,03	DC 1100	5	22	2,6
10	50 235 26.10	50 237 26.10	50 238 26.10	50 239 26.10	0,03	DC 1100	5	24	3,3
12	50 235 26.12	50 237 26.12	50 238 26.12	50 239 26.12	0,03	DC 1100	13	62	3,5
16	50 235 26.16	50 237 26.16	50 238 26.16	50 239 26.16	0,03	DC 1100	30	143	3,8
20	50 235 26.20	50 237 26.20	50 238 26.20	50 239 26.20	0,03	DC 1100	53	250	4,7
25	50 235 26.25	50 237 26.25	50 238 26.25	50 239 26.25	0,03	DC 1100	82	560	5,9
30	50 235 26.30	50 237 26.30	50 238 26.30	50 239 26.30	0,03	DC 1000	118	950	7,5

Applikationskoeffizienten / Application coefficients (Weiterführende Informationen siehe Seite 13 / for more information see page 13)

a	A2	B1 max.	B2	Cf3
130	0,9	1,25	0,5	0,8

**DC 1100 V Ø 14 x 65 mm**

**Zeit/Strom-Kennlinien**  
Time-current characteristics

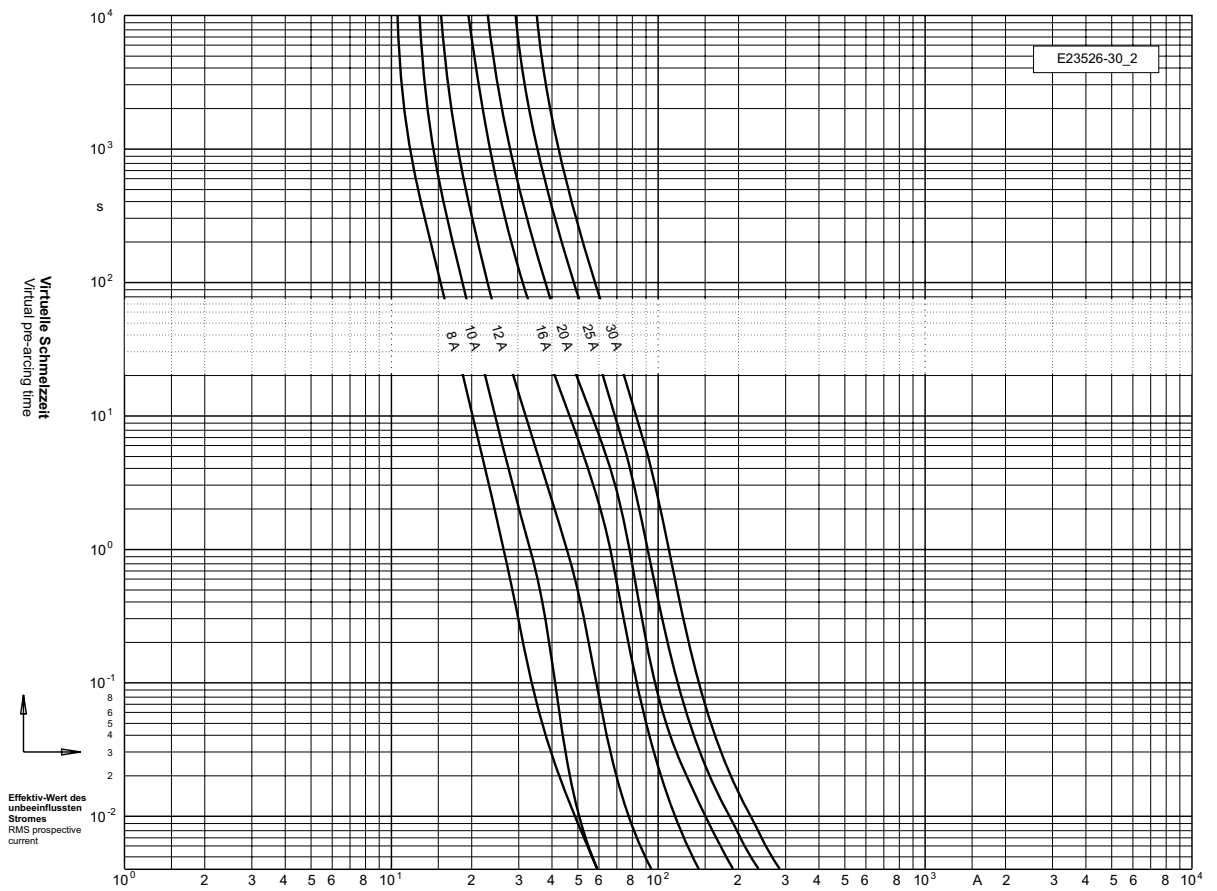

**DC 1100 V Ø 14 x 65 mm**

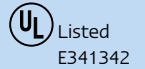

50 235 28



50 237 28



50 238 28

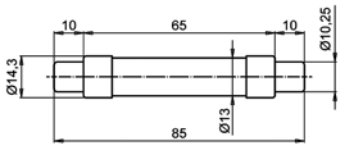

50 239 28



Verpackungseinheit / Packing unit: 10 Stück / 10 pieces

Betriebsklasse / Class <b>gPV</b>	<b>IEC 60 269-6</b> <b>UL 2579</b>
--------------------------------------	---------------------------------------

Bemessungs- spannung Rated Voltage	Artikel Nr. Article No	
V		
DC 1100	50 235 28	14 x 65 mm
	50 237 28	mit Anschraub- laschen with bolted contacts
	50 238 28	10/14 x 85 mm
	50 239 28	mit Anschraub- laschen with bolted contacts

**Bemessungsausschaltvermögen / Rated breaking capacity 30 kA DC 1100 V**  
L/R = 1-3 ms

Bemessungs- strom Rated Current	Artikel Nr. Article No.				Gewicht Weight	Bemessungs- spannung Rated Voltage	Schmelz- integral Pre-Arcing- I <sup>2</sup> t-Value	Ausschalt- integral Total I <sup>2</sup> t-Value	Leistungs- abgabe Power Loss
		mit Anschraub- laschen with bolted contacts		mit Anschraub- laschen with bolted contacts					
A					kg / 1	V	A <sup>2</sup> s	A <sup>2</sup> s	W
10	50 235 28.10	50 237 28.10	50 238 28.10	50 239 28.10	0,03	DC 1100	3	21	4,0
12	50 235 28.12	50 237 28.12	50 238 28.12	50 239 28.12	0,03	DC 1100	7,5	51	4,1
16	50 235 28.16	50 237 28.16	50 238 28.16	50 239 28.16	0,03	DC 1100	16	109	4,6
20	50 235 28.20	50 237 28.20	50 238 28.20	50 239 28.20	0,03	DC 1100	30	205	5,5
25	50 235 28.25	50 237 28.25	50 238 28.25	50 239 28.25	0,03	DC 1100	82	560	5,9

Applikationskoeffizienten / Application coefficients (Weiterführende Informationen siehe Seite 13 / for more information see page 13)

a	A2	B1 max.	B2	Cf3
130	0,8	1,25	0,5	0,8

**DC 1100 V Ø 14 x 65 mm** 

**Zeit/Strom-Kennlinien**  
Time-current characteristics

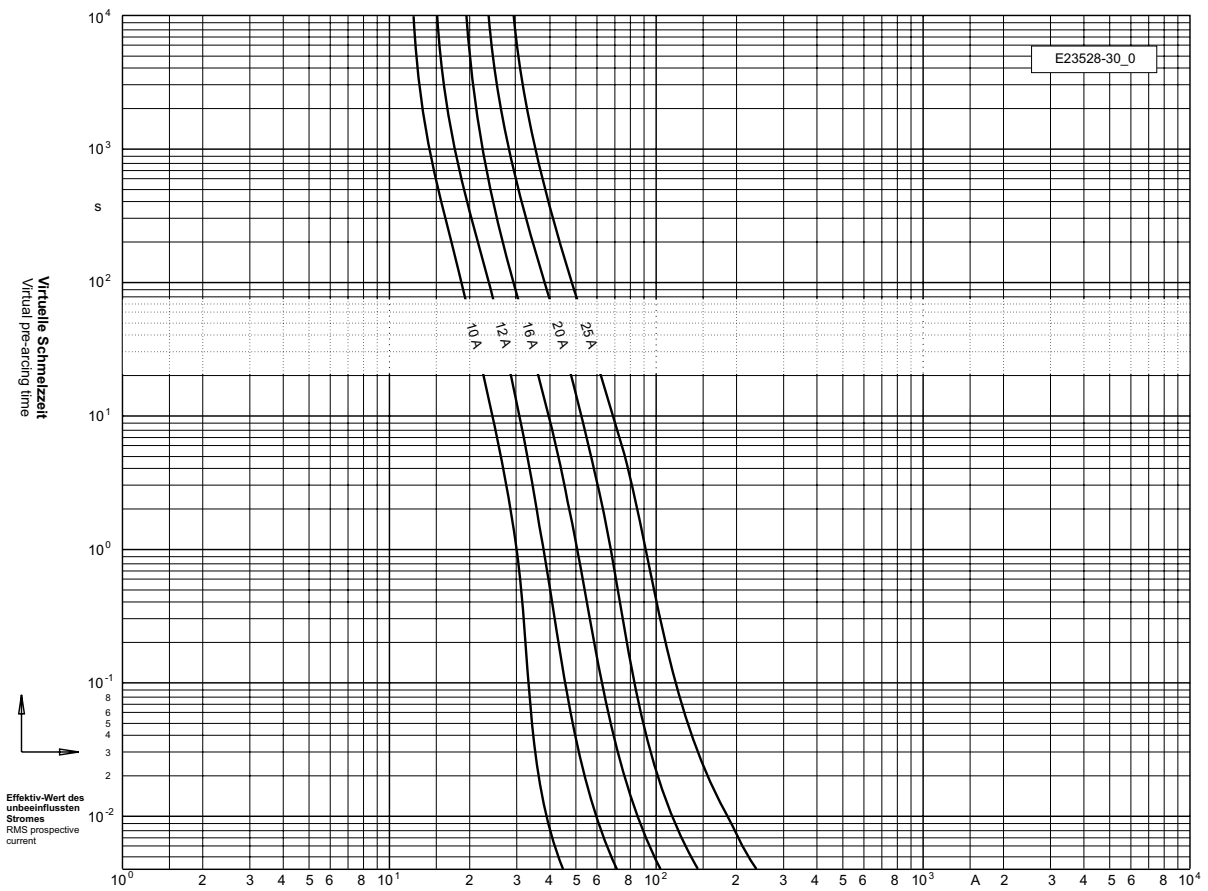

**DC 1200 V Ø 10 x 38 mm**



50 255 06

Verpackungseinheit / Packing unit: 10 Stück / 10 pieces

Betriebsklasse / Class <b>gR</b>	in Anlehnung an / in compliance with: <b>UL 248-13</b>
-------------------------------------	---

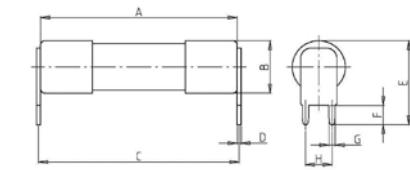

50 256 06

Bemessungs- spannung Rated Voltage	Artikel Nr. Article No	Größe Size	Bemessungsstrom Rated Current
V			A
DC 1200	50 255 06	10 x 38 mm	1
	50 256 06		

Bemessungsausschaltvermögen / Rated breaking capacity **30 kA**  
L/R = 3 ms

Bemessungsstrom Rated Current	Artikel Nr. Article No.	Gewicht Weight	Bemessungs- spannung Rated Voltage	Schmelzintegral Pre-Arcing- I <sup>2</sup> t-Value	Leistungs- abgabe Power Loss
A		kg / 1	V	A <sup>2</sup> s	W
1	50 255 06.1 50 256 06.1 mit Einlötpins for PCB mounting	0,01	DC 1200	0,32	3,5

Applikationskoeffizienten / Application coefficients (Weiterführende Informationen siehe Seite 13 / for more information see page 13)

a	A2	B1 max.	B2	CF3
130	0,6	1,25	0,5	0,8



**DC 1200 V Ø 10 x 38 mm**

Zeit/Strom-  
Kennlinien  
Time-current  
characteristics

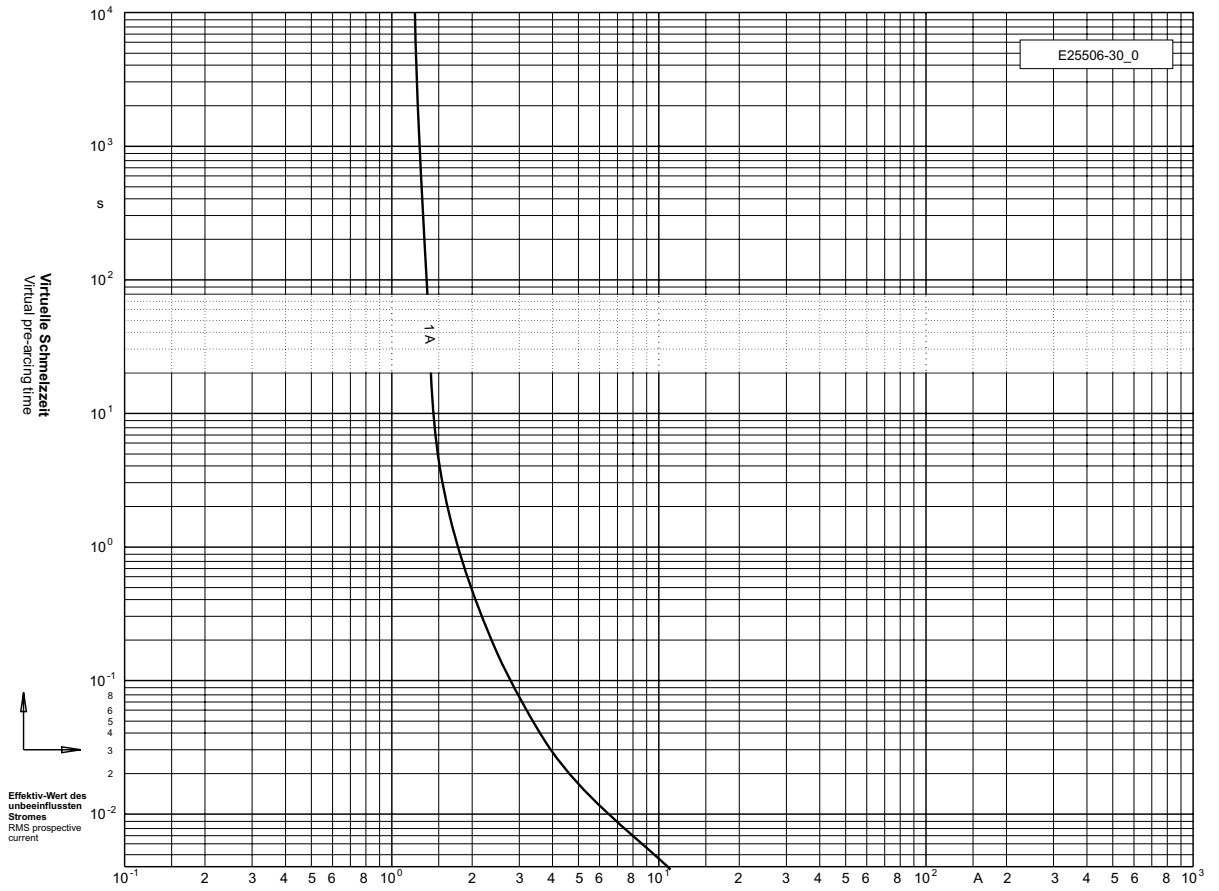

**DC 1500 V Ø 10 x 85 mm**

 Listed  
E341342

 Pending

Verpackungseinheit / Packing unit: 25 Stück / 25 pieces

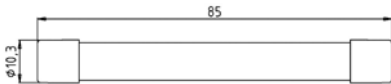

Betriebsklasse / Class  
**gPV**

**IEC 60 269-6**  
**UL 2579 (pending)**

Bemessungs- spannung Rated Voltage	Artikel Nr. Article No	Größe Size	Bemessungsstrom Rated Current
V			A
DC 1500	50 115 28	10 x 85 mm	1-16

Bemessungsausschaltvermögen / Rated breaking capacity **30 kA DC 1500 V**  
L/R = 1-3 ms

Bemessungsstrom Rated Current	Artikel Nr. Article No.	Gewicht Weight	Bemessungs- spannung Rated Voltage	Bemessungs- ausschaltvermögen Rated breaking capacity	Schmelzintegral Pre-Arcing- I <sup>2</sup> t-Value	Ausschaltintegral Total I <sup>2</sup> t-Value @ DC 1500 V	Leistungs- abgabe Power Loss
A		kg / 1	V	DC	A <sup>2</sup> s	A <sup>2</sup> s	W
1	50 115 28.1	0,02	DC 1500	30 kA @ 1500 V	0,3	0,5	1,6*
2	50 115 28.2	0,02	DC 1500	30 kA @ 1500 V	2,6	4,8	2,5*
3	50 115 28.3	0,02	DC 1500	30 kA @ 1500 V	5,2	8,8	3,5*
4	50 115 28.4	0,02	DC 1500	30 kA @ 1500 V	20	32	4,0*
5	50 115 28.5	0,02	DC 1500	30 kA @ 1500 V	30	45	4,2*
6	50 115 28.6	0,02	DC 1500	30 kA @ 1500 V	3,3	30	4,1
8	50 115 28.8	0,02	DC 1500	30 kA @ 1500 V	7	57	5,2
10	50 115 28.10	0,02	DC 1500	30 kA @ 1500 V	7,5	62	3,4
12	50 115 28.12	0,02	DC 1500	30 kA @ 1500 V	17	140	3,5
15	50 115 28.15	0,02	DC 1500	30 kA @ 1500 V	30	250	3,8
16	50 115 28.16	0,02	DC 1500	30 kA @ 1500 V	40	330	3,9

\* UL<sub>Listed</sub>: 10 kA @ DC 1500 V

Applikationskoeffizienten / Application coefficients (Weiterführende Informationen siehe Seite 13 / for more information see page 13)

a	A2	B1 max.	B2	Cf3
130	0,6	1,25	0,5	0,8

**DC 1500 V Ø 10 x 85 mm**

 Listed  
E341342

 Pending

**Zeit/Strom-  
Kennlinien**  
Time-current  
characteristics

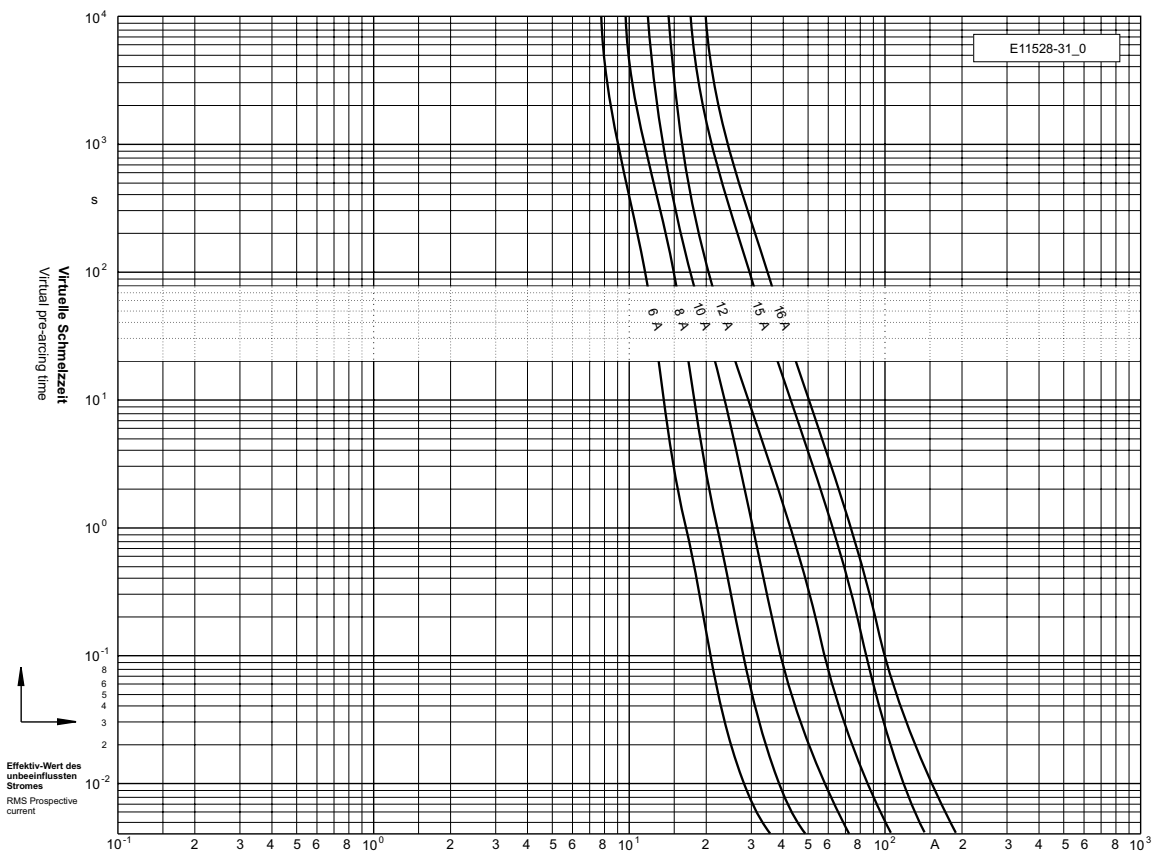
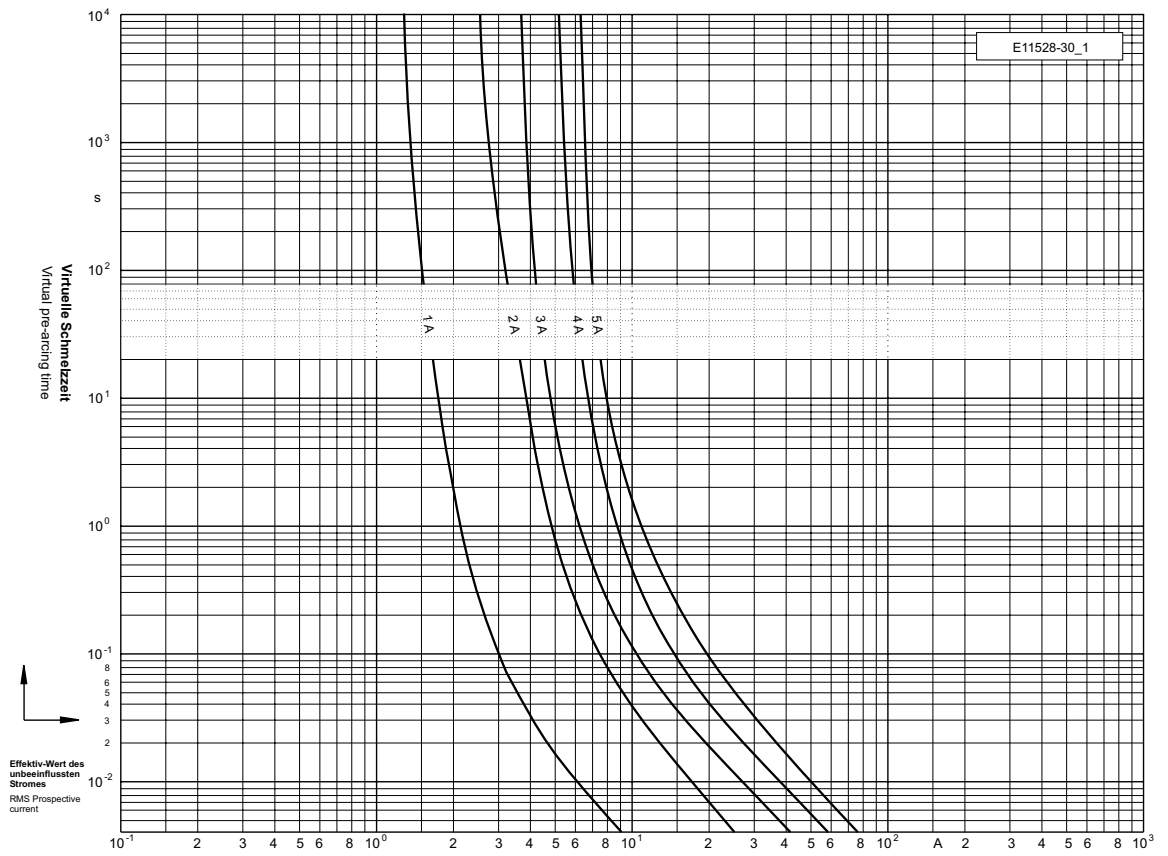

**DC 1500 V Ø 14 x 100 mm**

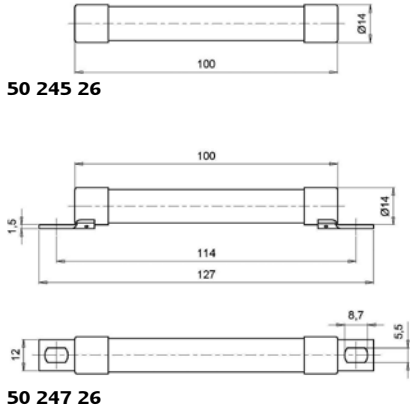

Verpackungseinheit / Packing unit: 10 Stück / 10 pieces

Betriebsklasse / Class <b>gPV</b>	<b>IEC 60 269-6</b>
--------------------------------------	---------------------

Bemessungs- spannung Rated Voltage	Artikel Nr. Article No
V	
DC 1500	50 245 26
	50 247 26 mit Anschraub- laschen with bolted contacts

Bemessungsausschaltvermögen / Rated breaking capacity **30 kA DC 1500 V**  
L/R = 3 ms

Bemessungsstrom Rated Current	Artikel Nr. Article No.	Gewicht Weight	Bemessungs- spannung Rated Voltage	Schmelz- integral Pre-Arcing- I <sup>2</sup> t-Value	Ausschalt- integral Total I <sup>2</sup> t-Value	Leistungs- abgabe Power Loss
				IEC 60269-6	@ tested Voltage	
A		kg / 1	V	A <sup>2</sup> s	A <sup>2</sup> s	W
12	50 245 26.12	0,04	DC 1500	14	140	4,2
16	50 245 26.16	0,04	DC 1500	30	290	5,5
20	50 245 26.20	0,04	DC 1500	53	510	6,5
25	50 245 26.25	0,04	DC 1500	91	880	7,5

Applikationskoeffizienten / Application coefficients (Weiterführende Informationen siehe Seite 13 / for more information see page 13)

a	A2	B1 max.	B2	Cf3
130	0,9	1,25	0,5	0,8

**DC 1500 V Ø 14 x 100 mm**

**Zeit/Strom-Kennlinien**  
Time-current characteristics

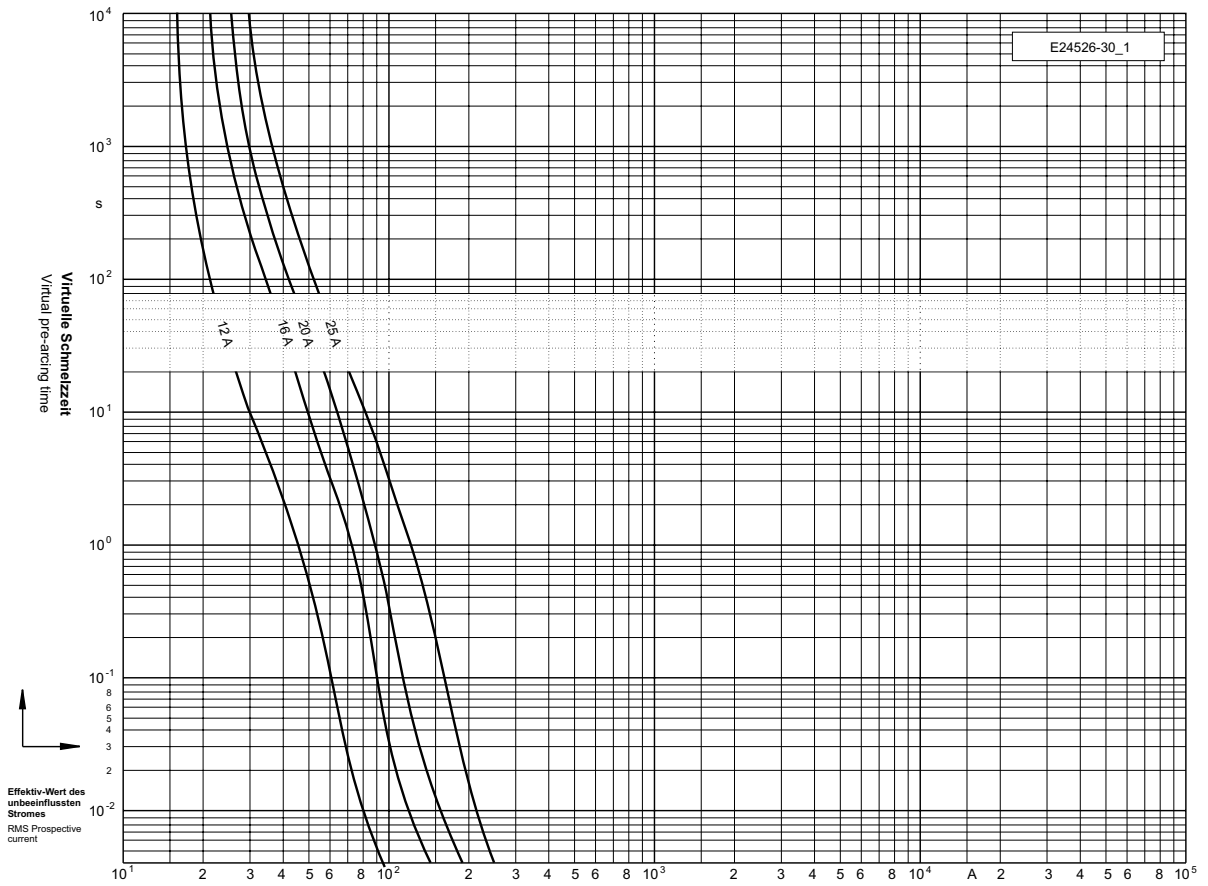

Effektiv-Wert des unbeeinflussten Stromes  
RMS Prospective current

**DC 1500 V Ø 20 x 127 mm**

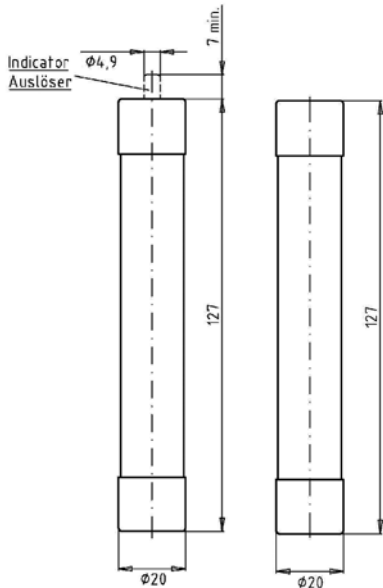

90 081 10    90 086 10  
90 081 10 <5A

Verpackungseinheit / Packing unit: 12 Stück / 12 pieces

Betriebsklasse / Class <b>aR</b> <b>gR</b>	IEC 60 269-4 VDE 0636-4	DIN EN 60269-4
--	----------------------------	----------------

Bemessungs- spannung Rated Voltage	Artikel Nr. Article No	Größe Size	Bemessungsstrom ohne Auslöser Rated Current without striker pin	Bemessungsstrom mit Auslöser Rated Current with striker pin
V			A	A
DC 1500	90 081 10	20 x 127 mm	< 5	≥ 5

Bemessungs- spannung Rated Voltage	Artikel Nr. Article No	Größe Size	Bemessungsstrom ohne Auslöser Rated Current without striker pin
V			A
DC 1500	90 086 10	20 x 127 mm	≥ 5

Bemessungsausschaltvermögen / Rated breaking capacity 30 kA

Bemessungsstrom Rated Current	Artikel Nr. Article No.	Gewicht Weight	Betriebsklasse Class	Schmelzintegral Pre-Arcing- I <sup>2</sup> t-Value	Ausschaltintegral Total I <sup>2</sup> t-Value	Leistungsabgabe Power Loss
A		kg / 1		A <sup>2</sup> s	A <sup>2</sup> s	W
					@ DC 1500 V	
2	90 081 10.2	0,36	aR	0,64	8	3,9
3,15	90 081 10.3,15	0,36	aR	2	16	4,1
5	90 081 10.5	0,36	gR	4,8	11	3,0
6	90 081 10.6	0,36	gR	3	17	3,0
8	90 081 10.8	0,36	gR	7	42	3,2
10	90 081 10.10	0,36	gR	13	75	3,4
12	90 081 10.12	0,36	gR	20	120	4,6
16	90 081 10.16	0,36	gR	52	300	5,7
20	90 081 10.20	0,36	gR	82	470	6,8
25	90 081 10.25	0,36	gR	118	670	8,1

Applikationskoeffizienten / Application coefficients (Weiterführende Informationen siehe Seite 13 / for more information see page 13)

a	A2	B1 max.	B2	Cf3
130	0,6	1,25	0,6	0,8

**DC 1500 V Ø 20 x 127 mm**

**Zeit/Strom-Kennlinien**  
Time-current characteristics

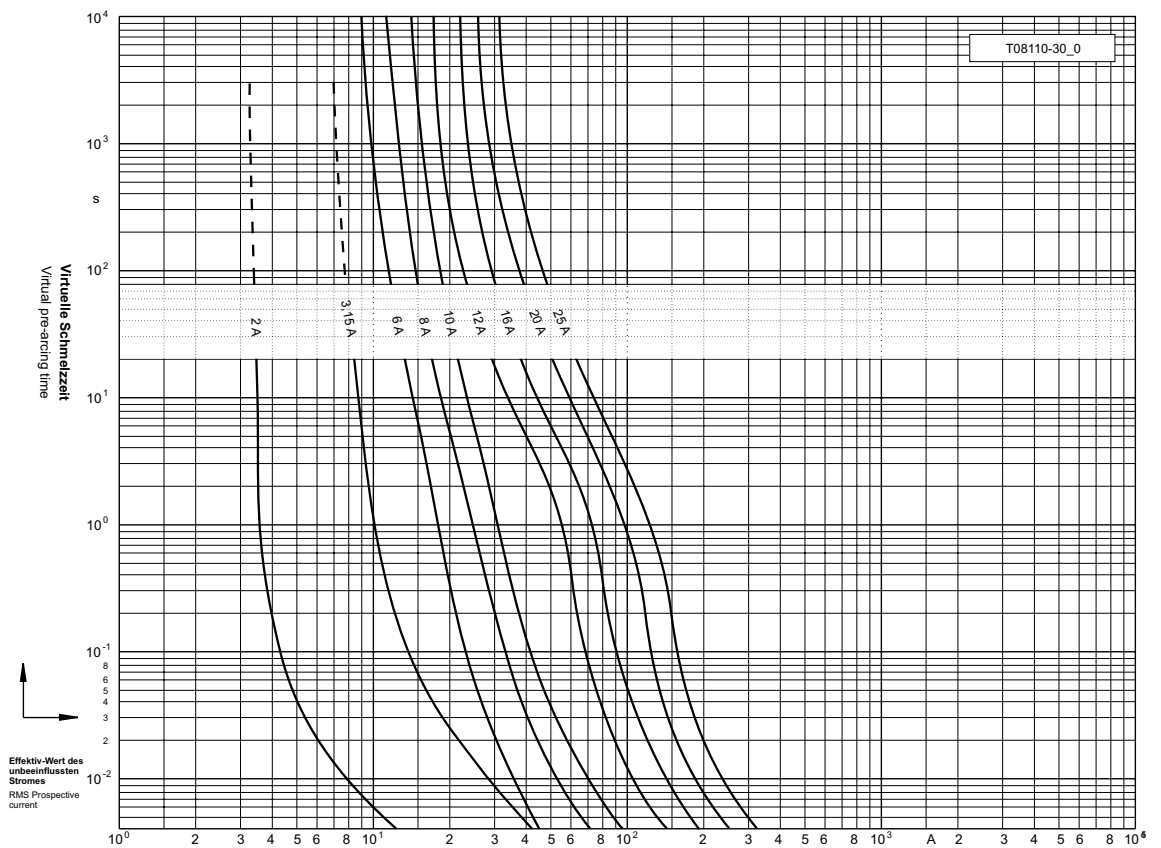
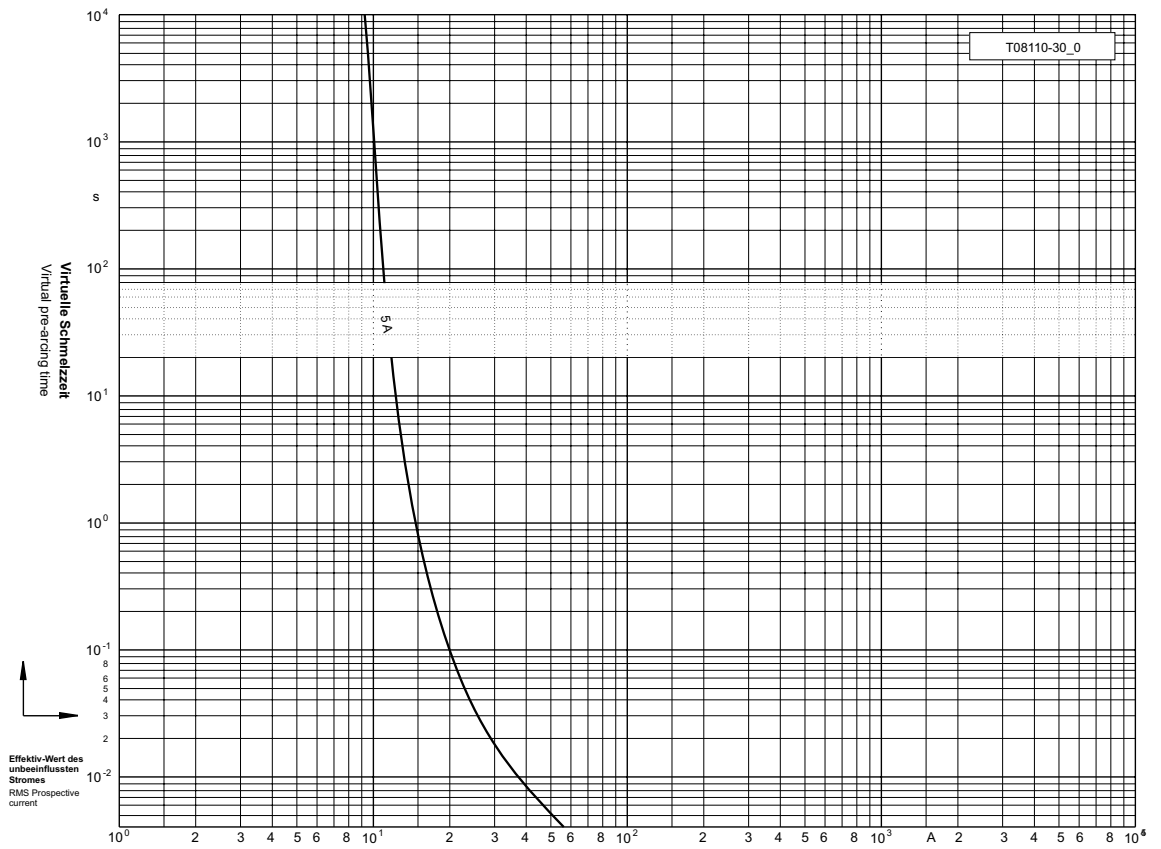

**DC 1500 V Ø 20 x 190 mm**

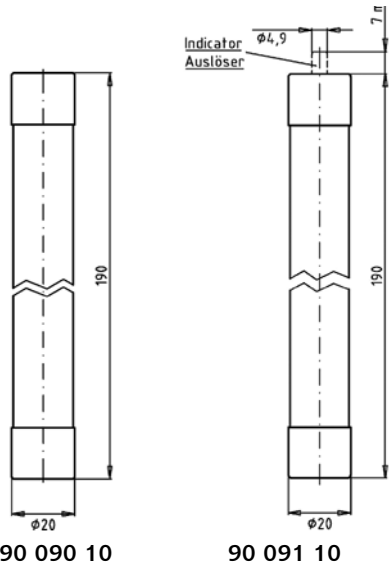

Verpackungseinheit / Packing unit: 6 Stück / 6 pieces

Betriebsklasse / Class <b>gR</b>	<b>IEC 60 077-5</b> <b>VDE 0115 Teil 460-5</b>	<b>UIC 550</b>
-------------------------------------	---	----------------

Bemessungs- spannung Rated Voltage	Artikel Nr. Article No	Größe Size	Bemessungs- strom Rated Current	Länge L Length L	Durchmesser D Diameter D
V			A	mm	mm
DC 1500	90 090 10	20 x 190	1-32	190	20
	90 091 10		1-32	190	20

Bemessungsausschaltvermögen / Rated breaking capacity 60 kA

Bemessungsstrom Rated Current	Artikel Nr. Article No.		Gewicht Weight	Schmelzintegral Pre-Arcing- I <sup>2</sup> t-Value	Ausschaltintegral Total I <sup>2</sup> t-Value @ DC 1500 V	Leistungsabgabe Power Loss
	Ohne Auslöser/ without striker	Mit Auslöser/ with striker				
	A	kg / 1				
1	90 090 10.1	90 091 10.1	0,11	0,2	1,3	2,8
2	90 090 10.2	90 091 10.2	0,11	0,9	5,3	4,1
3	90 090 10.3	90 091 10.3	0,11	2,6	16	4,5
4	90 090 10.4	90 091 10.4	0,11	7,3	45	5,6
6	90 090 10.6	90 091 10.6	0,11	7,4	44	3,1
8	90 090 10.8	90 091 10.8	0,11	13	80	4,1
10	90 090 10.10	90 091 10.10	0,11	30	180	4,4
12	90 090 10.12	90 091 10.12	0,11	53	320	4,7
16	90 090 10.16	90 091 10.16	0,11	90	550	6,2
20	90 090 10.20	90 091 10.20	0,11	150	900	7,6
25	90 090 10.25	90 091 10.25	0,11	240	1.400	8,1
32	90 090 10.32	90 091 10.32	0,11	600	3.600	9,7

Applikationskoeffizienten / Application coefficients (Weiterführende Informationen siehe Seite 13 / for more information see page 13)

a	A2	B1 max.	B2	Cf3
130	0,6	1,25	0,6	0,8



**DC 1500 V Ø 20 x 190 mm**

**Zeit/Strom-Kennlinien**  
Time-current characteristics

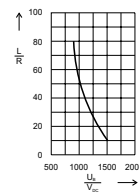
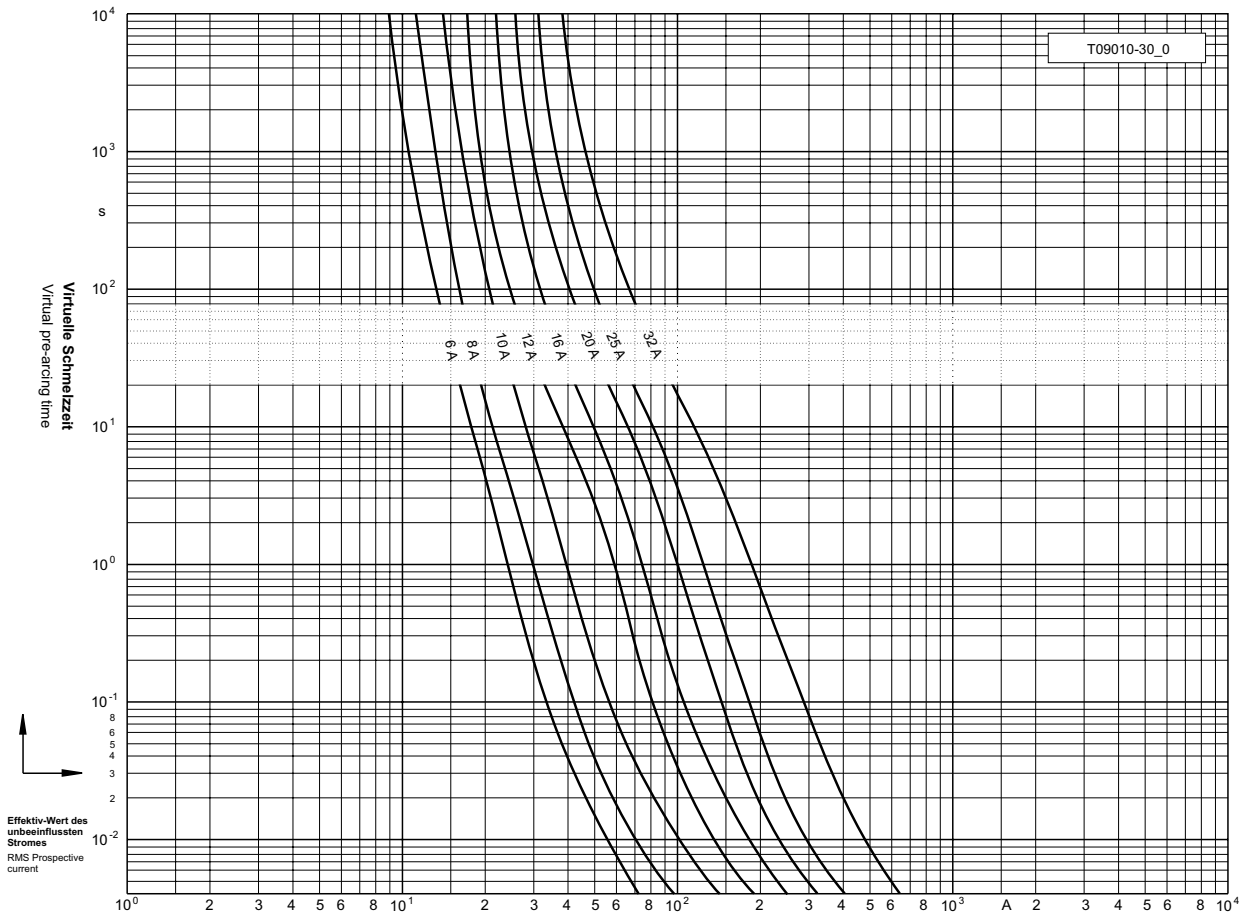

**Umrechnungsfaktor für die Bemessungsspannung bei diff. Zeitkonstanten**  
Correction factor for diff. time constant v.s. max. voltage

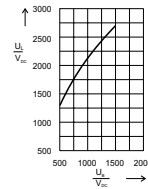

**Schaltspannungsdiagramm**  
Arc Voltage-Diagram

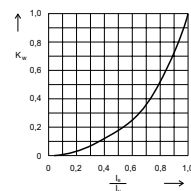

**Umrechnungsfaktor der Leistungsabgabe**  
Reduction factor for power Loss

**DC 1500 V Ø 36 x 190 mm**

Verpackungseinheit / Packing unit: 1 Stück / 1 pieces

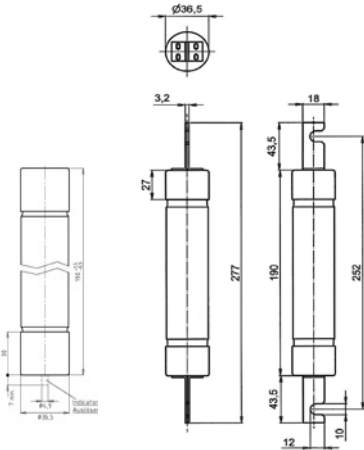

Betriebsklasse / Class <b>gR</b>	in Anlehnung an / in compliance with: <b>VDE 0636-1 und -4</b>
-------------------------------------	---

Bemessungs- spannung Rated Voltage	Artikel Nr. Article No	Größe Size	Bemessungs- strom Rated Current	Länge L Length L	Durchmesser D Diameter D
V			A	mm	mm
DC 1500	90 094 10	36 x 190	20-100	190	36,5
	90 095 10		20-100	190	36,5
	90 098 10		20-100	190	36,5

90 094 10  
90 095 10

90 098 10

Bemessungsausschaltvermögen / Rated breaking capacity 30 kA (L/R = 15ms)

Bemessungs- strom Rated Current	Artikel Nr. Article No.			Gewicht Weight	Schmelzintegral Pre-Arcing- I <sup>2</sup> t-Value	Ausschalt- integral Total I <sup>2</sup> t-Value	Leistungs- abgabe * Power Loss
	Ohne Auslöser/ without striker	Mit Auslöser/ with striker	Stichmaß 252 mm fixing center 252 mm				
A				kg / 1	A <sup>2</sup> s	@ DC 1500 V L/R=30 ms A <sup>2</sup> s	W
20	90 094 10.20	90 095 10.20	90 098 10.20	0,50/0,61	60	470	9
25	90 094 10.25	90 095 10.25	90 098 10.25	0,50/0,61	100	770	12
32	90 094 10.32	90 095 10.32	90 098 10.32	0,50/0,61	130	950	16
40	90 094 10.40	90 095 10.40	90 098 10.40	0,50/0,61	290	2.200	22
50	90 094 10.50	90 095 10.50	90 098 10.50	0,50/0,61	620	4.600	25
63	90 094 10.63	90 095 10.63	90 098 10.63	0,50/0,61	1.000	7.500	30
80	90 094 10.80	90 095 10.80	90 098 10.80	0,50/0,61	2.050	15.300	34
100	90 094 10.100	90 095 10.100	90 098 10.100	0,50/0,61	3.500	25.800	38

Applikationskoeffizienten / Application coefficients (Weiterführende Informationen siehe Seite 13 / for more information see page 13)

a	A2	B1 max.	B2	CF3
130	0,6	1,25	0,6	0,8

**DC 1500 V Ø 36 x 190 mm**

**Zeit/Strom-  
Kennlinien**  
Time-current  
characteristics

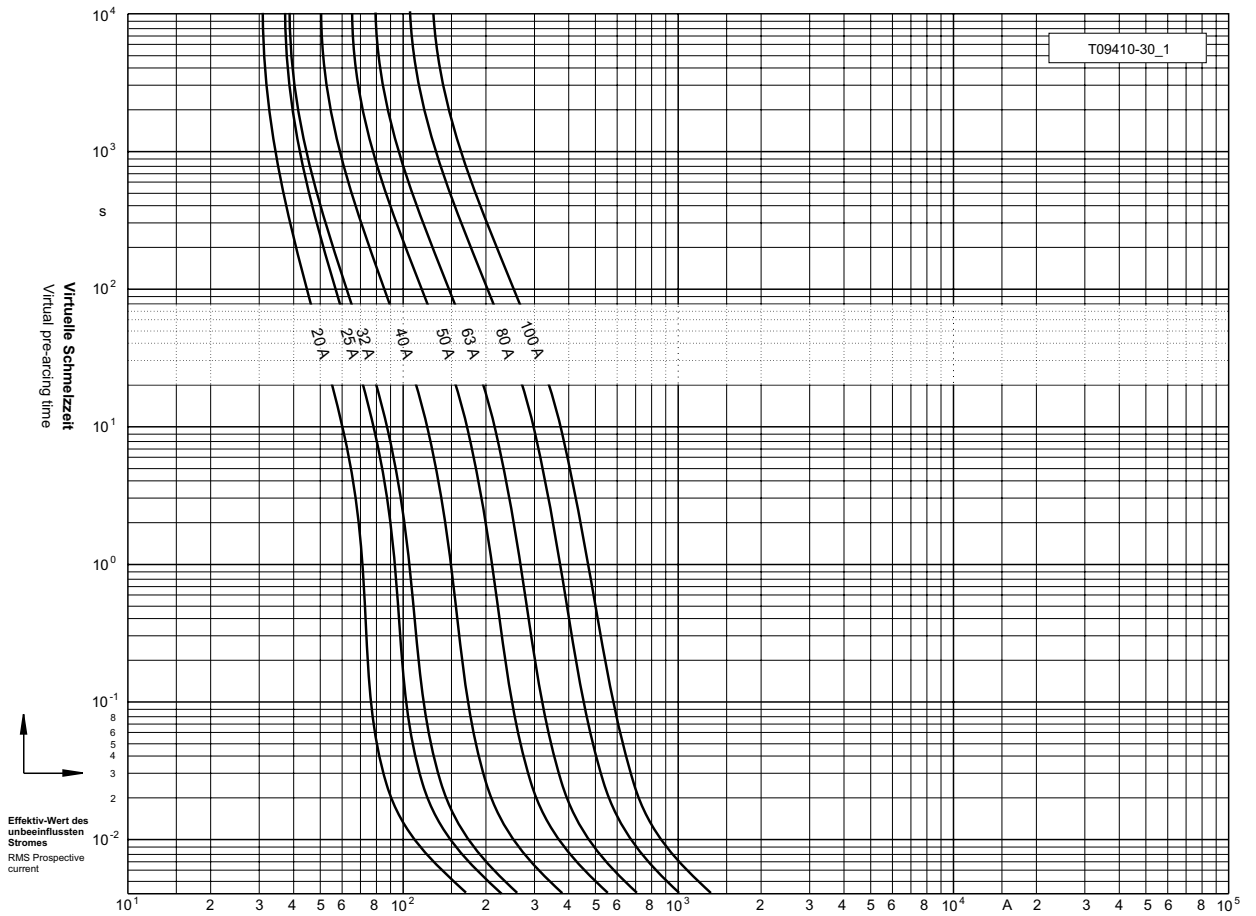

Effektiv-Wert des  
unbeeinflussten  
Stromes  
RMS Prospective  
current

**DC 2000 V Ø 36 x 250 mm**

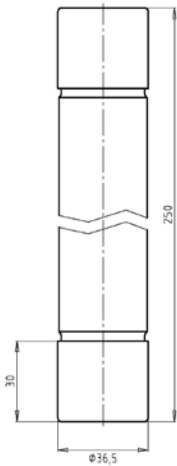

90 096 10

Verpackungseinheit / Packing unit: 1 Stück / 1 pieces

Betriebsklasse / Class <b>gR</b>	in Anlehnung an / in compliance with: <b>VDE 0636-1 und -4</b>
-------------------------------------	---

Bemessungs- spannung Rated Voltage	Artikel Nr. Article No	Größe Size	Bemessungs- strom Rated Current	Länge L Length L	Durchmesser D Diameter D
V			A	mm	mm
DC 2000	90 096 10	36 x 250	2-40	250	36,5

Bemessungsausschaltvermögen / Rated breaking capacity 30 kA (L/R = 20ms)

Bemessungsstrom Rated Current	Artikel Nr. Article No.	Gewicht Weight	Schmelzintegral Pre-Arcing- I <sup>2</sup> t-Value	Ausschaltintegral Total I <sup>2</sup> t-Value  @ DC 2000 V L/R=20 ms	Leistungsabgabe * Power Loss
A	Ohne Auslöser/ without striker	kg / 1	A <sup>2</sup> s	A <sup>2</sup> s	W
2	90 096 10.2	1,90	2,5	3,5	7
6	90 096 10.6	1,90	17	54	10
12	90 096 10.12	1,90	102	330	17
16	90 096 10.16	1,90	72	360	14
20	90 096 10.20	1,90	81	430	14
25	90 096 10.25	1,90	154	820	18
32	90 096 10.32	1,90	250	1.350	22
40	90 096 10.40	1,90	414	2.200	26

Applikationskoeffizienten / Application coefficients (Weiterführende Informationen siehe Seite 13 / for more information see page 13)

a	A2	B1 max.	B2	Cf3
130	0,6	1,25	0,6	0,8

**DC 2000 V Ø 36 x 250 mm**

Zeit/Strom-  
Kennlinien  
Time-current  
characteristics

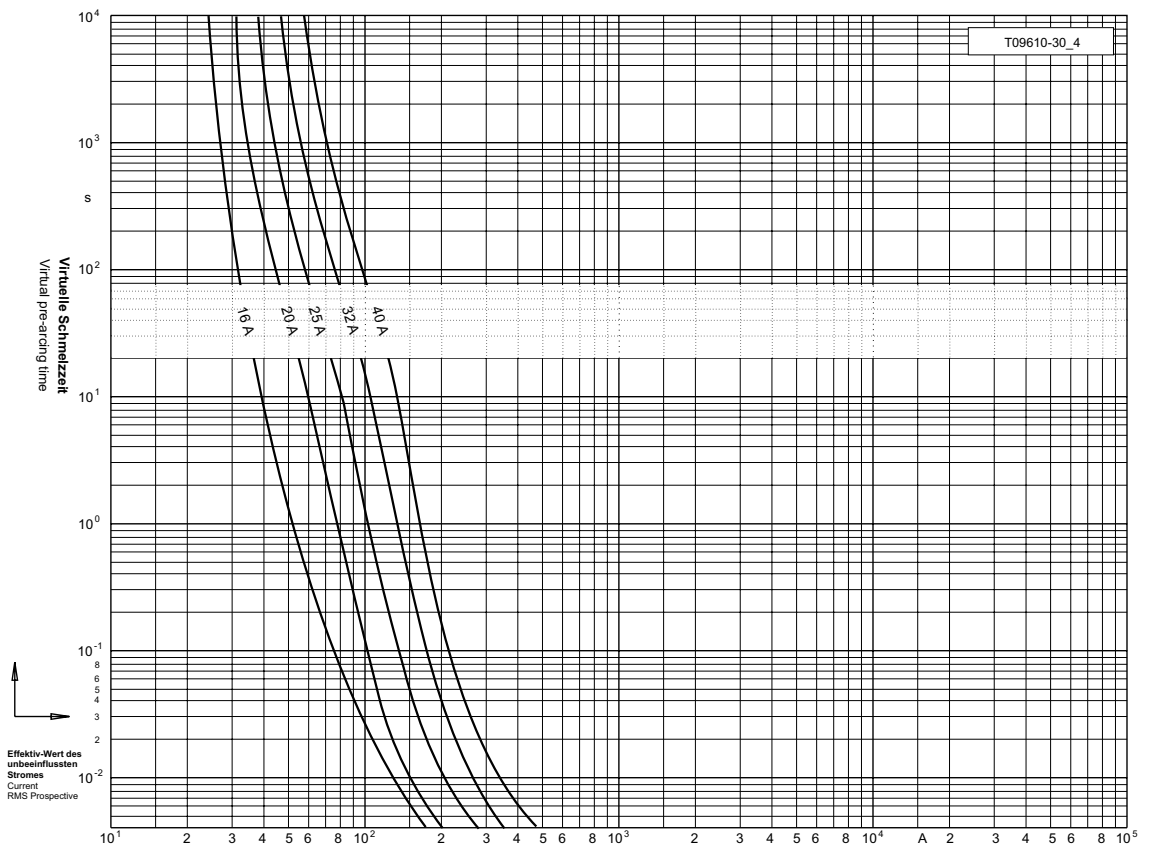
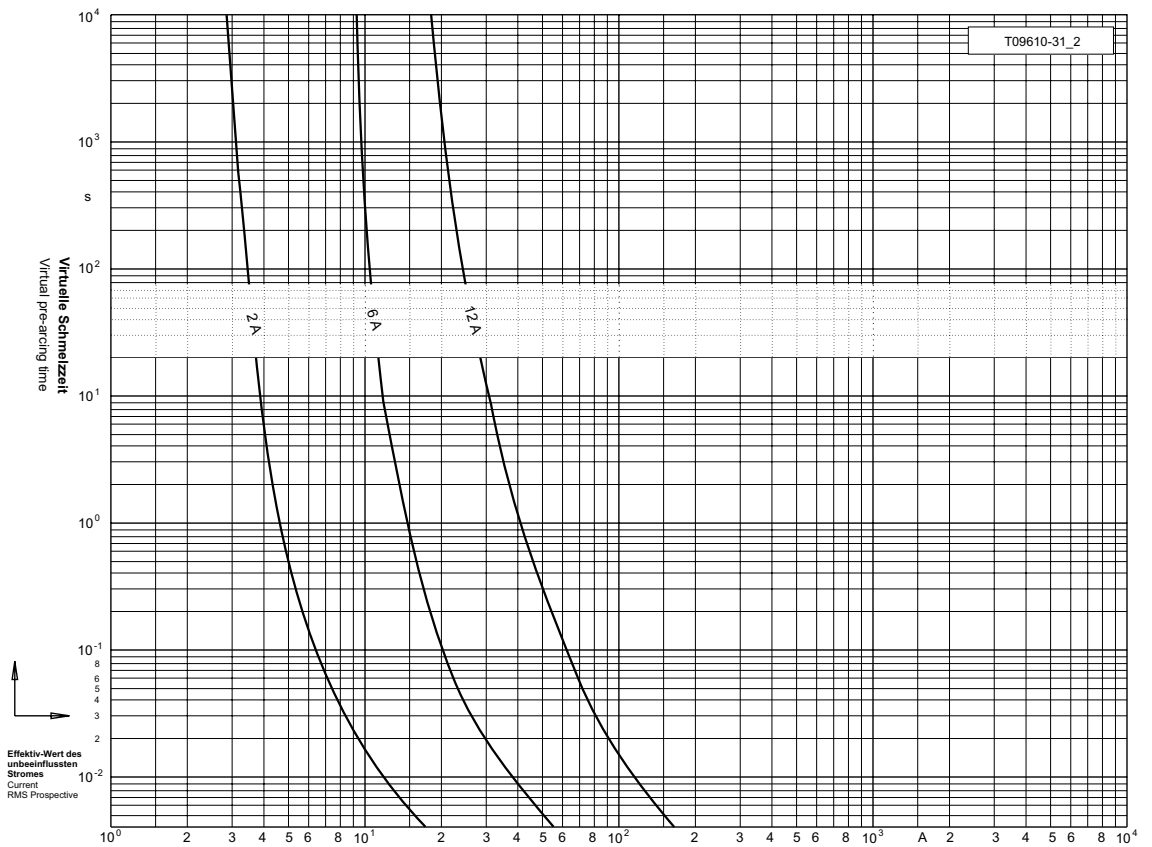

**DC 4000 V Ø 39,6 x 254 mm**

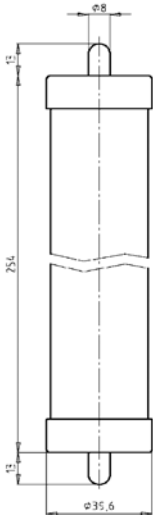

Verpackungseinheit / Packing unit: 1 Stück / 1 pieces

Betriebsklasse / Class <b>gR</b>	<b>IEC 60 077-5 UIC 550</b>
-------------------------------------	---------------------------------

Bemessungs- spannung Rated Voltage	Artikel Nr. Article No	Größe Size	Bemessungs- strom Rated Current	Länge L Length L	Durchmesser D Diameter D
V			A	mm	mm
DC 3600	90 100 10	39,6 x 254	2-20	254	39,6

Bemessungsausschaltvermögen / Rated breaking capacity **3,2 kA (L/R = 16ms)**  
**1,6 kA (L/R = 11ms)**

Bemessungsstrom Rated Current	Artikel Nr. Article No.	Gewicht Weight	Schaltspannung Switching Voltage	Schmelzintegral Pre-Arcing- I <sup>2</sup> t-Value	Ausschaltintegral Total I <sup>2</sup> t-Value	Leistungs- abgabe * Power Loss
A		kg / 1	kV	A <sup>2</sup> s	A <sup>2</sup> s	W
2	90 100 10.2	0,78	15	2,5	3,5	9
3,15	90 100 10.3,15	0,78	15	4	8	13
3,9	90 100 10.3,9	0,78	15	8	13	24
5	90 100 10.5	0,78	15	15	21	18
6,3	90 100 10.6,3	0,78	15	24	41	22
8	90 100 10.8	0,78	10	27	110	21
12,5	90 100 10.12,5	0,78	10	68	220	40
16	90 100 10.16	0,78	10	72	360	23
20	90 100 10.20	0,78	10	120	600	27

Applikationskoeffizienten / Application coefficients (Weiterführende Informationen siehe Seite 13 / for more information see page 13)

a	A2	B1 max.	B2	Cf3
130	0,6	1,25	0,6	0,8

**DC 4000 V Ø 39,6 x 254 mm**

**Zeit/Strom-  
Kennlinien**  
Time-current  
characteristics

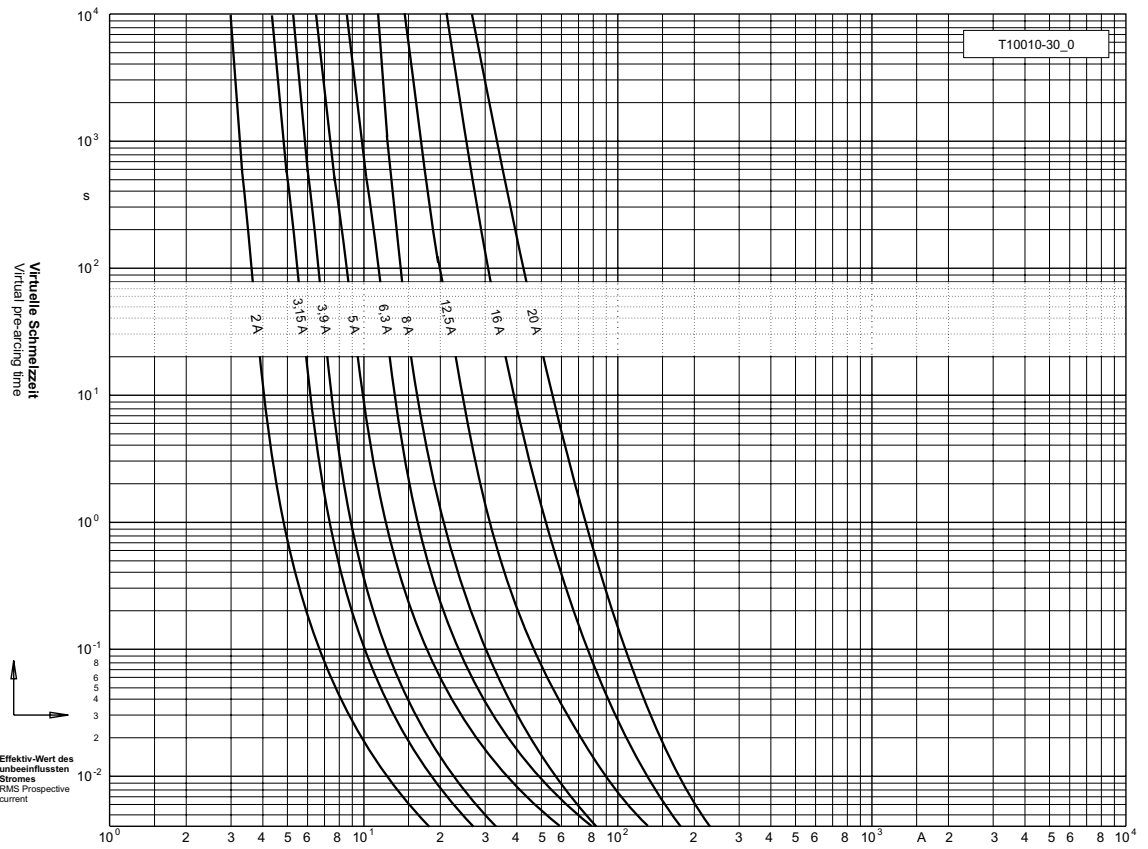

Ø 10

Clip für Direkt- und Leiterplattenmontage  
Clip for Direct- and PCB-mounting

58 063 16

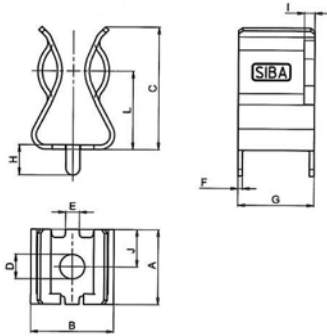

58 063 19

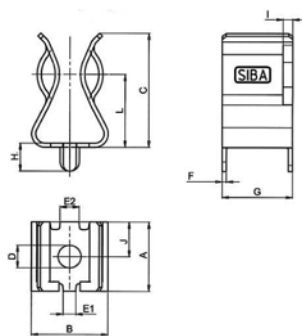

mit Verdrehungsschutz  
with twist protection

58 063 17

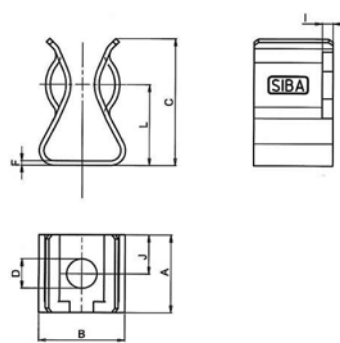

63 017 01

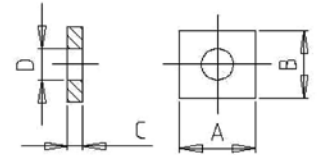

63 017 01.3

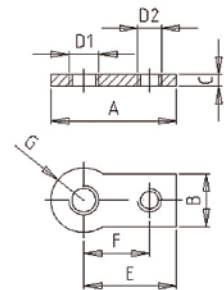

Verpackungseinheit / Packing unit:	100 Stück / 100 pieces	100 Stück / 100 pieces	100 Stück / 100 pieces	1000 Stück / 1000 pieces	1000 Stück / 1000 pieces
IEC 60269-2	Kontaktclip Fuse-Clip PCB Mountable <b>58 063 16</b>	Kontaktclip Fuse-Clip PCB Mountable <b>58 063 19</b>	Kontaktclip Fuse-Clip PCB Mountable <b>58 063 17</b>	Anschraubplatte Clamping Plate <b>63 017 01</b>	Anschlusslasche Terminal Link <b>61 017 01.3</b>
IEC 60269-3	<b>10 x 38 mm</b>				
IEC 60269-4	Bemessungsleistungsaufnahme 4 W / Rated Power Acceptance 4 W				
	Kupferlegierung CuSn, verzinkt / Copper alloy CuSn, tin-plated	Kupferlegierung CuSn, verzinkt / Copper alloy CuSn, tin-plated	Kupferlegierung CuSn, verzinkt / Copper alloy CuSn, tin-plated	Kupferlegierung CuSn, vernickelt / Copper alloy CuSn, nickel-plated	Kupferlegierung CuSn, versilbert / Copper alloy CuSn, silver-plated
A	11,0 mm	11,0 mm	11,0 mm	10,0 mm	21,0 mm
B	12,0 mm	12,0 mm	12,0 mm	9,0 mm	6,0 mm
C	18,0 mm	18,0 mm	18,0 mm	2,0 mm	2,0 mm
D	3,6 mm	3,6 mm	4,2 mm	4,2 mm	-
D1	-	-	-	-	M5
D2	-	-	-	-	M4
E	2,0 mm	-	-	-	15,5 mm
E1	-	2,0 mm	-	-	-
E2	-	3,0 mm	-	-	-
F	0,65 mm	0,65 mm	0,65 mm	-	11,0 mm
G	11,0 mm	11,0 mm	-	-	5,5 mm
H	4,45 mm	4,45 mm	-	-	-
I	1,5 mm	1,5 mm	1,5 mm	-	-
J	5,5 mm	5,5 mm	5,5 mm	-	-
K	-	-	-	-	-
L	11,5 mm	11,5 mm	11,5 mm	-	-
Gewicht/Weight kg/1	0,003	0,003	0,003	0,001	0,003



**Ø 14**

## Clip für Direkt- und Leiterplattenmontage Clip for Direct- and PCB-mounting

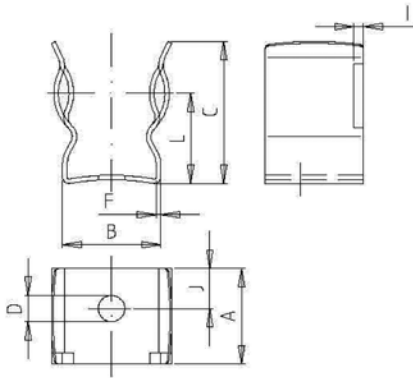
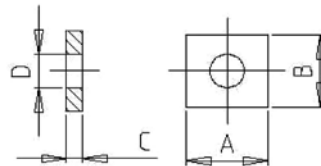
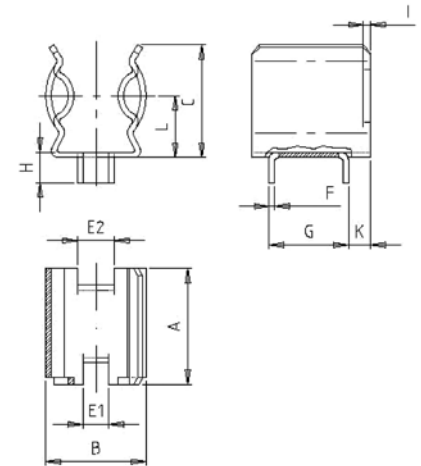
**61 001 01.2**

**63 017 01**

**58 058 06.**

Verpackungseinheit / Packing unit:	100 Stück / 100 pieces	1000 Stück / 1000 pieces	500 Stück / 500 pieces
IEC 60269-2	Anschraubclip Fuse-Clip Screw Mountable <b>61 001 01.2</b>	Anschraubplatte Clamping Plate <b>63 017 01</b>	Einlötdclip Fuse-Clip PCB Mountable <b>58 058 06</b>
IEC 60269-3	<b>14 x 51 mm</b>		
IEC 60269-4	Bemessungsleistungsaufnahme 6 W / Rated Power Acceptance 6 W		
	Kupferlegierung CuSn, vernickelt / Copper alloy CuSn, nickel-plated	Kupferlegierung CuSn, vernickelt / Copper alloy CuSn, nickel-plated	Kupferlegierung CuSn, verzinkt / Copper alloy CuSn, tin-plated
A	15,5 mm	10,0 mm	16,0 mm
B	15,5 mm	9,0 mm	12,0 mm
C	22,8 mm	2,0 mm	15,5 mm
D	4,2 mm	4,2 mm	-
E1	-	-	3,5 mm
E2	-	-	5,0 mm
F	0,7 mm	-	0,75 mm
G	-	-	10,7 mm
H	-	-	4,2 mm
I	1,5 mm	-	1,0 mm
J	6,5 mm	-	-
K	-	-	3,0 mm
L	14,5 mm	-	8,5 mm
Gewicht/Weight kg/1	0,006	0,001	0,004

Ø 20/22

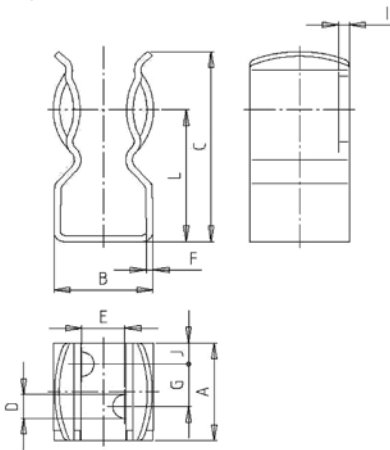
Clip für Direkt- und Leiterplattenmontage  
Clip for Direct- and PCB-mounting

61 002 01.3



63 002 01

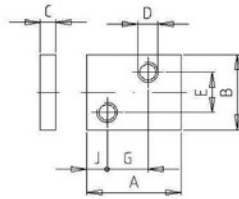

63 002 01.4

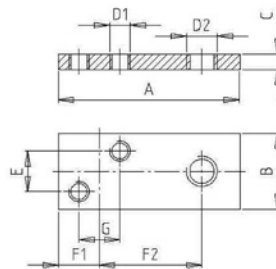

58 060 06

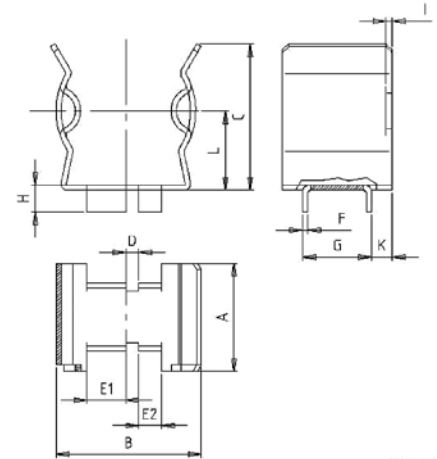

Verpackungseinheit / Packing unit:	100 Stück / 100 pieces	100 Stück / 100 pieces	100 Stück / 100 pieces	1000 Stück / 1000 pieces
IEC 60269-2	Anschraubclip Fuse-Clip Screw Mountable <b>61 002 01.3</b>	Anschraubplatte Clamping Plate <b>63 002 01</b>	Anschraublasche Terminal Link <b>61 002 01.4</b>	Einlötklip Fuse-Clip PCB Mountable <b>58 060 06</b>
IEC 60269-3	<b>20,6 x 127 mm / 22 x 58 mm</b>			
IEC 60269-4	Bemessungsleistungsaufnahme 6 W / Rated Power Acceptance 6 W			
	Kupferlegierung CuSn, vernickelt / Copper alloy CuSn, nickel-plated	Kupferlegierung CuSn, vernickelt / Copper alloy CuSn, nickel-plated	Kupferlegierung CuSn, vernickelt / Copper alloy CuSn, nickel-plated	Kupferlegierung CuSn, verzinnt / Copper alloy CuSn, tin-plated
A	18,5 mm	18,5 mm	35,5 mm	17,0 mm
B	18,4 mm	15,0 mm	15,0 mm	20,0 mm
C	36,0 mm	3,0 mm	3,0 mm	23,0 mm
D	4,5 mm	M4	-	2,0 mm
D1	-	-	M4	-
D2	-	-	M6	-
E	8,0 mm	8,0 mm	8,0 mm	-
E1	-	-	-	6,0 mm
E2	-	-	-	3,5 mm
F	1,2 mm	-	-	0,8 mm
F1	-	-	7,5 mm	-
F2	-	-	8,0 mm	-
G	8,0 mm	8,0 mm	8,0 mm	10,7 mm
H	-	-	-	4,2 mm
I	2,0 mm	-	-	1,0 mm
J	4,0 mm	4,0 mm	-	-
K	-	-	-	3,5 mm
L	25,0 mm	-	-	12,5 mm
Gewicht/Weight kg/1	0,020	0,010	0,012	0,008

Ø 27/36

Clip für Direkt- und Leiterplattenmontage  
Clip for Direct- and PCB-mounting

61 004 01.3

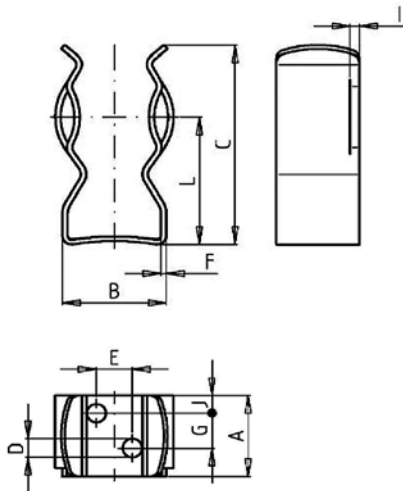

91 094 01.3

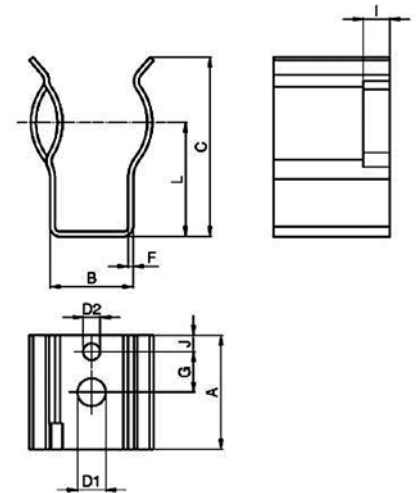

63 002 01

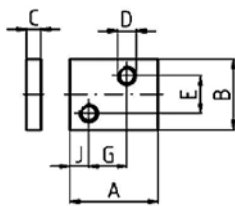

91 094 01.4

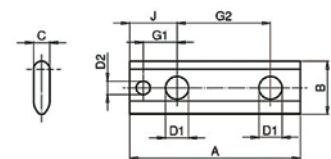

Verpackungseinheit / Packing unit:	100 Stück / 100 pieces	100 Stück / 100 pieces	100 Stück / 100 pieces	100 Stück / 100 pieces
IEC 60269-2	Anschraubclip Fuse-Clip Screw Mountable <b>61 004 01.3</b>	Anschraubplatte Clamping Plate <b>63 002 01</b>	Anschraubclip Fuse-Clip Screw Mountable <b>91 094 01.3</b>	Anschraub-/Kontaktplatte Clamping-/Contact-Plate <b>91 094 01.4</b>
IEC 60269-3	<b>27 x 60 mm / 27 x 140 mm / 36 x 127 mm / 36 x 190 mm / 36 x 250 mm</b>			
IEC 60269-4	Bemessungsleistungsaufnahme 6 W / Rated Power Acceptance 6 W			
	Kupferlegierung CuSn, vernickelt / Copper alloy CuSn, nickel-plated	Kupferlegierung CuSn, vernickelt / Copper alloy CuSn, nickel-plated	Kupferlegierung CuSn, vernickelt / Copper alloy CuSn, nickel-plated	Kupferlegierung CuSn, vernickelt / Copper alloy CuSn, nickel-plated
A	18,5 mm	18,5 mm	35,0 mm	63,0 mm
B	23,2 mm	15,0 mm	25,0 mm	20,0 mm
C	45,5 mm	3,0 mm	55,0 mm	6,0 mm
D	4,3 mm	M4	-	-
D1	-	-	8,5 mm	8,5 mm
D2	-	-	5,1 mm	5,1 mm
E	8,0 mm	8,0 mm	-	-
F	1,2 mm	-	1,5 mm	-
G	8,0 mm	8,0 mm	12,5 mm	-
G1	-	-	-	12,5 mm
G2	-	-	-	34,5 mm
I	2,0 mm	-	8,0 mm	-
J	4,0 mm	4,0 mm	5,0 mm	17,5 mm
L	29,0 mm	-	35,0 mm	-
Gewicht/Weight kg/1	0,018	0,010	0,018	0,133

690 V

URZ-U-Sicherungshalter  
URZ-U-Fuse-Holder

10 x 38 mm

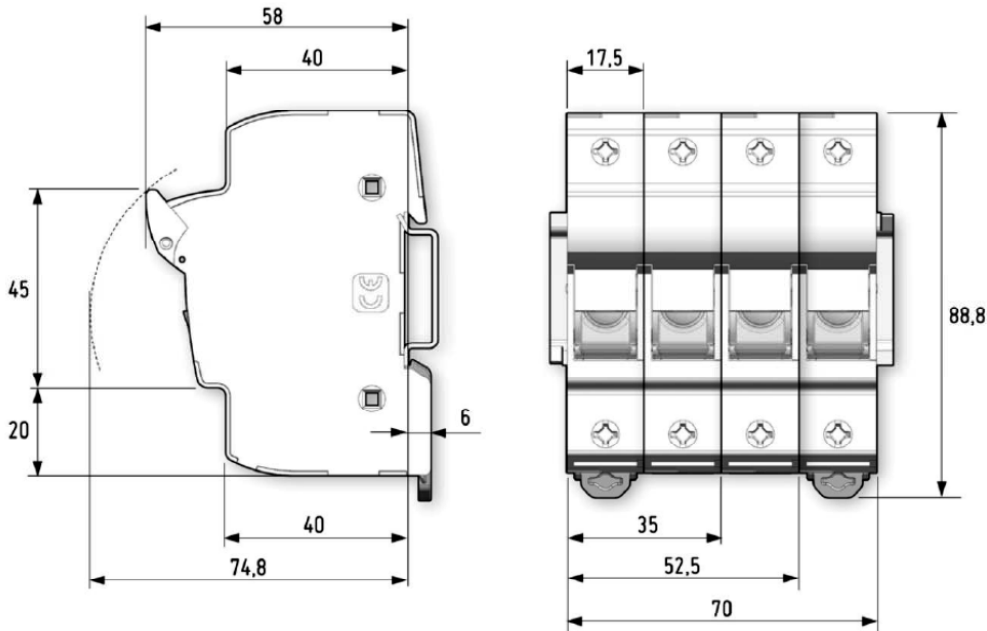
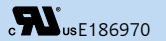

Type	Größe	ZS-Module	ZS-Module mit Meldeleuchte	Verpackungseinheit / Packing unit	Größe
Type	Size	ZS-Module	ZS-Module with indicator lamp	Stück / pieces	kg / 1
	mm				
1 pol.	10 x 38	51 063 05.1	51 063 05.1L	6	0,57
2 pol.		51 063 05.2	51 063 05.2L	3	1,14
3 pol.		51 063 05.3	51 063 05.3L	2	1,71
4 pol.		51 063 05.4	51 063 05.4L	1	2,28

IEC 60269-2  
IEC 60947-3  
VDE 0660-107  
NFC 61201 / NFC 63001  
UNE 20129 / UNE 21103

Bemessungsspannung Rated Voltage	Artikel Nr. Article No.	Bemessungsstrom Rated Current	Bemessungsleistungsaufnahme Rated Power Acceptance	Max. Anschlussquerschnitt Max. Connecting Cable	Max. Anzugsmoment Max. Tightening Torque	Gebrauchskategorie Utilization Category	Schutzklasse Degree of protection
V		A	W	mm <sup>2</sup>	Nm		
690	51 063 05.	32	4	25	2,5	690 V: AC-21B 750 V: DC-20B	IP-20

Anzahl der Pole No. of poles	Artikel Nr. Article No.		Artikel-Nr. / Article No. 51 063 05.
		Gehäuse / Body	Thermoplast. Polyester / Thermoplastic polyester
		Sicherungsträger / Handle	Thermoplast. Polyester / Thermoplastic polyester
	51 063 05.	Kontakte / Contacts	Kupfer, versilbert / Silver plating copper
1-3	1	Flammbareitsklasse „UL 94“ / Flammability "UL 94"	V2
4-6	0,8	Max. Gebrauchstemperatur / Max. Function Temperature	-50 ... +85 °C
7-9	0,7	Lagertemperatur / Storage	-50 ... +85 °C
> 10	0,6	Funktionsbereich Meldeleuchte / Rating of lightning indicator	AC / DC 120-750 V

690 V

URZ-U-Sicherungshalter  
URZ-U-Fuse-Holder

14 x 51 mm



usE180276  
750 V

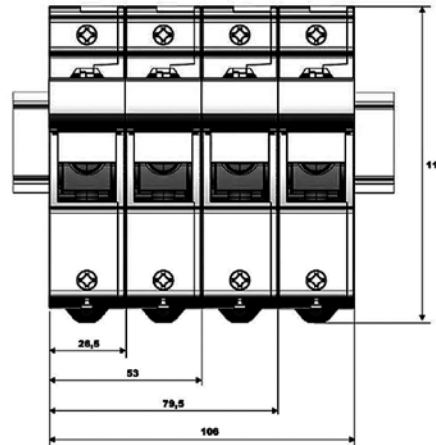
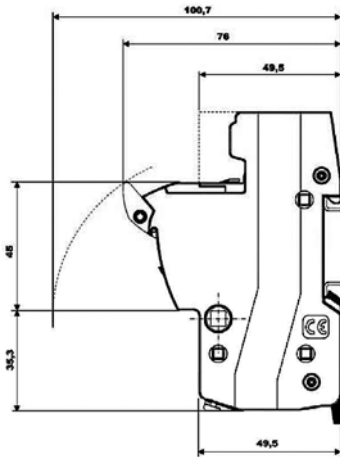

Type	Größe	ZS-Module	ZS-Module mit Mikroschalter	ZS-Module mit Meldeleuchte	Verpackungseinheit / Packing unit	Gewicht
Type	Size	ZS-Module	ZS-Module with micro switch	ZS-Module with lightning indicator	Stück / pieces	Weight
	mm					kg / 1
1 pol.	14 x 51	51 058 05.1	51 058 05.1S	51 058 05.1L	6	0,12
2 pol.		51 058 05.2	51 058 05.2S	51 058 05.2L	3	0,25
3 pol.		51 058 05.3	51 058 05.3S	51 058 05.3L	2	0,35

IEC 60269-1 / IEC 60269-2  
IEC 60947-1 / IEC 60947-2  
VDE 0636-1 / VDE 0636-2  
VDE 0660-100 / VDE 0660-107  
UL 4248-1 / CSA 22.2

Bemessungs- spannung Rated Voltage	Artikel Nr. Article No.	Bemessungs- strom Rated Current	Bemessungs- leistungsaufnahme Rated Power Acceptance	Max. Anschluss- querschnitt Max. Connecting Cable	Max. Anzugs- moment Max. Tightening Torque	Gebrauchskategorie Utilization Category	VSchutzklasse Degree of protection
V		A	W	mm <sup>2</sup>	Nm		
690 IEC 750 UL	51 058 05.1 51 058 05.2 51 058 05.3	50	6	1,5-35 solid wire 1,5-25 stranded wire	3	690 V: AC-21B 500 V: AC-22B	IP 20

Anzahl der Pole	Artikel Nr.
No. of poles	Article No.
	51 058 05.
1-3	1
4-6	0,8
7-9	0,7
> 10	0,6

	Artikel-Nr. / Article No.
	51 058 05.
Gehäuse / Body	Thermoplast. Polyester / Thermoplastic polyester
Sicherungsträger / Handle	Thermoplast. Polyester / Thermoplastic polyester
Kontakte / Contacts	Kupfer, versilbert / Silver plating copper
Flammbarkeitsklasse „UL 94“ / Flammability "UL 94"	V0
Max. Gebrauchstemperatur / Max. Function Temperature	-50 ... +85 °C
Lagertemperatur / Storage	-50 ... +85 °C
Funktionsbereich Meldeleuchte / Rating of lightning indicator	AC/DC 230-750 V

690 V

URZ-U-Sicherungshalter **22 x 58 mm**  
URZ-U-Fuse-Holder

**RU**  
usE186970  
750 V

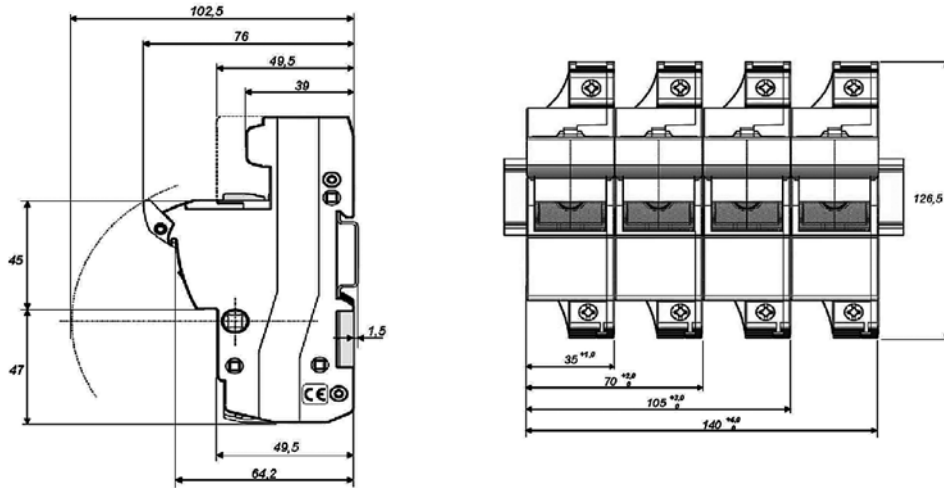

Type	Größe	ZS-Module	ZS-Module mit Mikroschalter	ZS-Module mit Meldeleuchte	Verpackungseinheit / Packing unit	Gewicht
Type	Size	ZS-Module	ZS-Module with micro switch	ZS-Module with lightning indicator	Stück / pieces	Weight
	mm					kg / 1
1 pol.	22 x 58	51 060 05.1	51 060 05.1S	51 060 05.1L	6	0,18
2 pol.		51 060 05.2	51 060 05.2S	51 060 05.2L	3	0,48
3 pol.		51 060 05.3	51 060 05.3S	51 060 05.3L	2	0,53

**IEC 60269-1 / IEC 60269-2  
IEC 60947-1 / IEC 60947-2  
VDE 0636-1 / VDE 0636-2  
VDE 0660-100 / VDE 0660-107  
UL 4248-1 / CSA 22.2**

Bemessungsspannung Rated Voltage	Artikel Nr. Article No.	Bemessungsstrom Rated Current	Bemessungsleistungsaufnahme Rated Power Acceptance	Max. Anschlussquerschnitt Max. Connecting Cable	Max. Anzugsmoment Max. Tightening Torque	Gebrauchskategorie Utilization Category	VSchutzklasse Degree of protection
V		A	W	mm <sup>2</sup>	Nm		
690 IEC 750 UL	51 060 05.1 51 060 05.2 51 060 05.3	125 IEC 100 UL	12	1,5-50 solid wire 1,5-35 stranded wire	4	690 V: AC-21B	IP 20

**Nennstromkorrekturfaktor / Derating of rated current: K<sub>2s</sub>**

Anzahl der Pole No. of poles	Artikel Nr. Article No.		Artikel-Nr. / Article No. 51 060 05.
		Gehäuse / Body	Thermoplast. Polyester / Thermoplastic polyester
		Sicherungsträger / Handle	Thermoplast. Polyester / Thermoplastic polyester
	51 060 05.	Kontakte / Contacts	Kupfer, versilbert / Silver plating copper
1-3	1	Flammbarkeitsklasse „UL 94“ / Flammability "UL 94"	V0
4-6	0,8	Max. Gebrauchstemperatur / Max. Function Temperature	-50 ... +85 °C
7-9	0,7	Lagertemperatur / Storage	-50 ... +85 °C
> 10	0,6	Funktionsbereich Meldeleuchte / Rating of lightning indicator	AC/DC 230-750 V

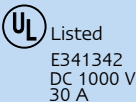
**DC 1000 V** URZ-U-Sicherungshalter **10 x 38 mm**   Listed  
E341342  
DC 1000 V  
30 A

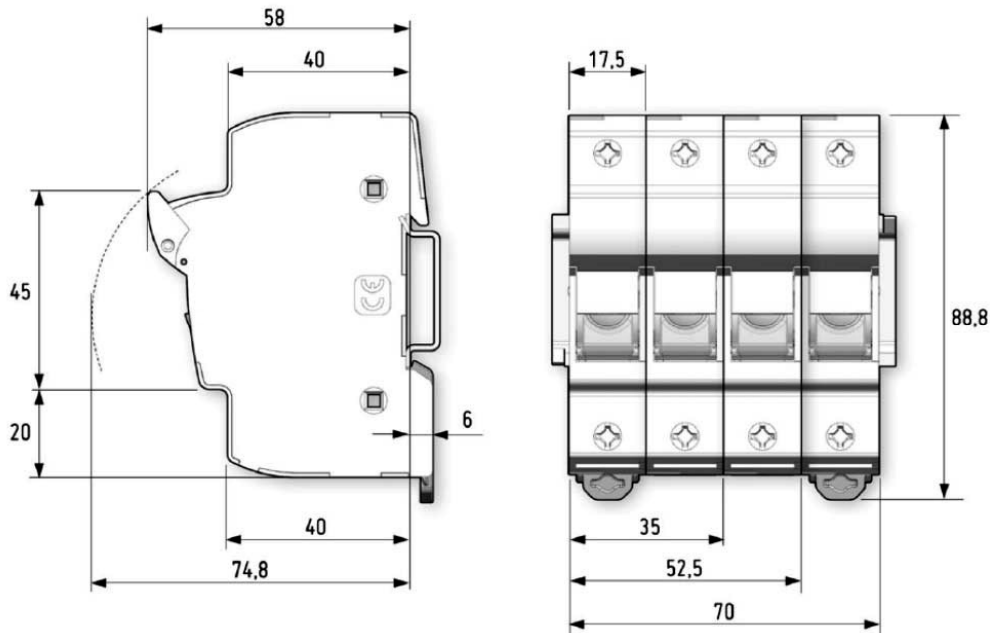

Type	Größe	ZS-Module	ZS-Module mit Meldeleuchte	Verpackungseinheit / Packing unit	Größe
Type	Size	ZS-Module	ZS-Module with indicator lamp		Size
	mm			Stück / pieces	kg / 1
1 pol.	10 x 38	51 063 05.1DC	51 063 05.1LDC	6	0,57
2 pol.		51 063 05.2DC	51 063 05.2LDC	3	1,14

IEC 60269-1 / IEC 60269-2  
IEC 60947-1 / IEC 60947-3  
UL 4248-1 / CSA 22.2  
UL 4248-18 / UL 486E

Bemessungsspannung	Artikel Nr.	Bemessungsstrom	Bemessungsleistungsaufnahme	Max. Anschlussquerschnitt	Max. Anzugsmoment	Gebrauchskategorie	Isolationsspannung	Schutzklasse
Rated Voltage	Article No.	Rated Current	Rated Power Acceptance	Max. Connecting Cable	Max. Tightening Torque	Utilization Category	Insulating Voltage	Degree of protection
V		A	W	mm <sup>2</sup>	Nm		kV	
DC 1000	51 063 05.1DC	30	4	0,75-16 solid wire 0,75-16 stranded wire	2,5	690V: AC-21B 1000V:DC-20B	8	IP-20
	51 063 05.2DC							

Anzahl der Pole	Artikel Nr.	
No. of poles	Article No.	
	51 063 05.	Artikel-Nr. / Article No. 51 063 05...DC
		Gehäuse / Body Thermoplast. Polyester / Thermoplastic polyester
		Sicherungsträger / Handle Thermoplast. Polyester / Thermoplastic polyester
		Kontakte / Contacts Kupfer, versilbert / Silver plating copper
		Flammbarkeitsklasse „UL 94“ / Flammability „UL 94“ V0
1-3	1	Max. Gebrauchstemperatur / Max. Function Temperature -50 ... +85 °C
4-6	0,8	
7-9	0,7	Bemerkungen / Remarks Lastfrei schalten / not to open under load
> 10	0,6	Zuleitung oben / supply side on top only
		Funktionsbereich Meldeleuchte / Rating of lightning indicator AC/DC 350-1000 V

**DC 1000 V**

URZ-U-Sicherungshalter  
URZ-U-Fuse-Holder

**14 x 51 mm**

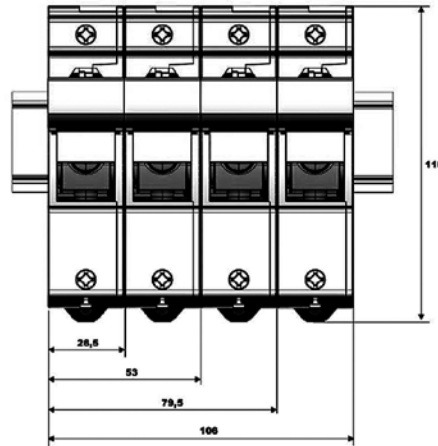
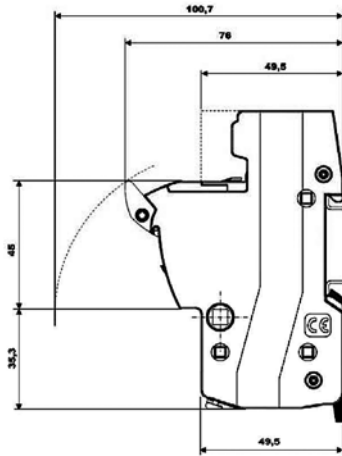

Type	Größe	ZS-Module	ZS-Module mit Anzeiger	Verpackungseinheit / Packing unit	Gewicht
Type	Size	ZS-Module	ZS-Module with indicator	Stück / pieces	Weight
	mm				kg / 1
1 pol.	14 x 51	51 058 05.1DC	51 058 05.1LDC	6	0,12
2 pol.		51 058 05.2DC	51 058 05.2LDC	3	0,23

IEC 60269-1 / IEC 60269-2  
IEC 60947-1 / IEC 60947-3  
UL 4248-1  
CSA 22.2

Bemessungsspannung Rated Voltage	Artikel Nr. Article No.	Bemessungsstrom Rated Current	Bemessungsleistungsaufnahme Rated Power Acceptance	Max. Anschlussquerschnitt Max. Connecting Cable	Max. Anzugsmoment Max. Tightening Torque	Isolationsspannung Insulating Voltage	Schutzklasse Degree of protection
V		A	W	mm <sup>2</sup>	Nm	kV	
DC 1000	51 058 05.1DC	50	6	1,5-35 solid wire 1,5-25 stranded wire	3	8	IP-20

Anzahl der Pole No. of poles	Artikel Nr. Article No.		Artikel-Nr. / Article No. 51 058 05...DC
		Gehäuse / Body	Thermoplast. Polyester / Thermoplastic polyester
		Sicherungsträger / Handle	Thermoplast. Polyester / Thermoplastic polyester
	51 058 05.	Kontakte / Contacts	Kupfer, versilbert / Silver plating copper
1-4	1	Flammbarkeitsklasse „UL 94“ / Flammability "UL 94"	V0
5-6	0,8	Max. Gebrauchstemperatur / Max. Function Temperature	-50 ... +85 °C
7-9	0,7	Funktionsbereich Anzeiger / Rating of indicator	350 - 1000 V DC
> 10	0,6	Bemerkungen / Remarks	Lastfrei schalten / not to open under load



**DC 1500 V** Sicherungshalter **10/14 x 85 mm**  
Fuse-base

Verpackungseinheit / Packing unit: 10 Stück / 10 pieces

Bemessungsspannung Rated Voltage	Artikel Nr. Article No	Gewicht Weight	Bemessungsstrom Rated Current	Max. Leistungsaufnahme Rated Power Acceptance	Max. Anzugsdrehmoment (Unterteil) Max. Fuse base Torque	Standard
V		kg / 1	A	W	Nm	Standard
DC 1500/AC 1000	51 238 05	0,20	32	6	2,5	IEC 60269-1

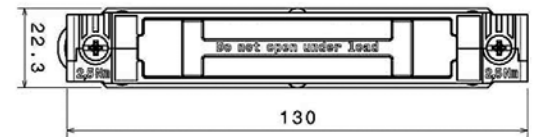
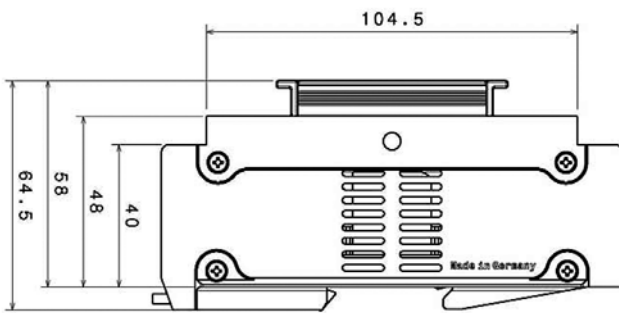

**DC 1500 V** URZ-Sicherungstrenner **20 x 127 mm**  
URZ-Fuse-disconnector **20 x 127 mm**

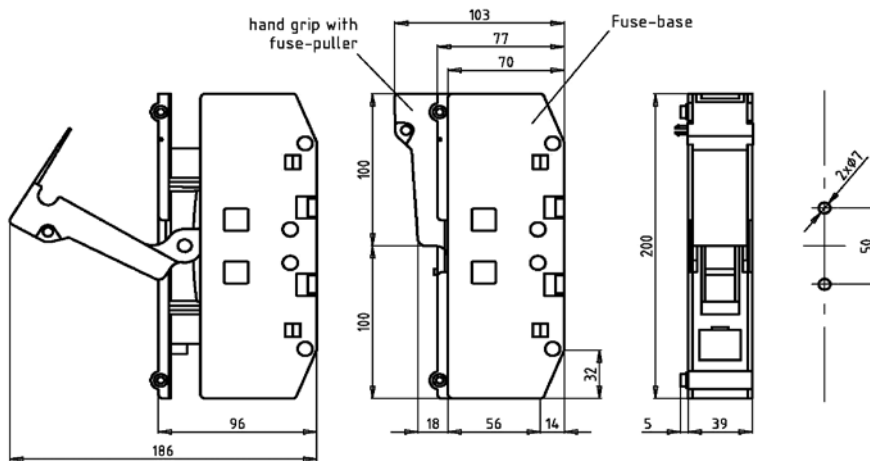

**IEC 60947-3**  
**AC 20 B, DC 20 B**

Verpackungseinheit / Packing unit: 1 Stück / 1 pieces

Bemessungs- spannung Rated Voltage	Artikel Nr. Article No.	Gewicht Weight	Bemessungsstrom Rated Current	Max. Leistungs- aufnahme Rated Power Acceptance	Max. Anschluss- querschnitt Max. Connecting Cable	Max. Anzugsmoment Max. Tightening Torque
V		kg / 1	A	W	mm <sup>2</sup>	Nm
1500	91 080 01.	0,50	63	15	50	10

**DC 1500 V**

Sicherungsunterteile für URT-Sicherungseinsätze  
Fuse-base for URT Fuse-links

**36 x 190 mm**

Verpackungseinheit / Packing unit: 1 Stück / 1 pieces

Bemessungs- spannung	Artikel Nr.	Größe	Gewicht	Bemessungs- strom	Max. Leistungsauf- nahme	Anschluß- bolzen	Max. Anzugs- drehmoment (Anschluß- bolzen)	Max. Anzugs- drehmoment (Unterteil)	Kontaktplatte
Rated Voltage	Article No	Size	Weight	Rated Current	Rated Power Acceptance	Connection bolts	Max. Nut Torque	Max. Fuse base Torque	Contact plate
V		mm	kg / 1	A	W		Nm	Nm	
DC 1500	91 094 01	36 x 190	1,22	100		M 8	22	20	Kupfer, versilbert copper, silver plated

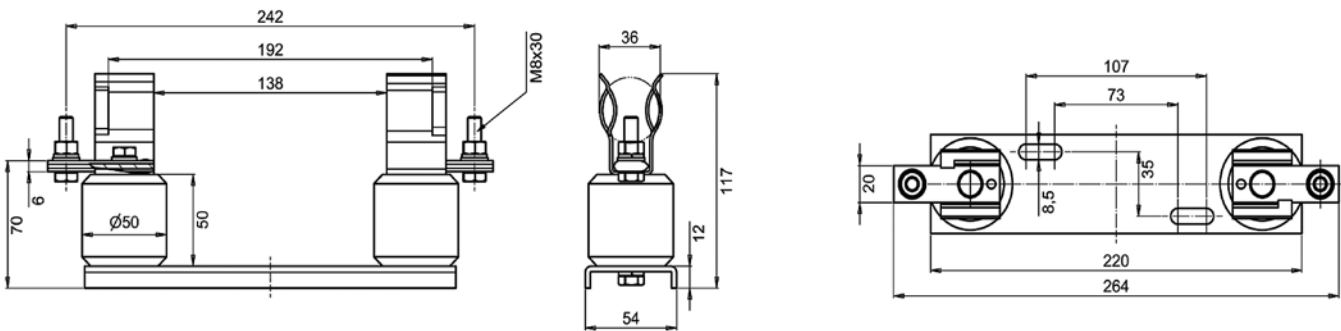

**DC 2000 V**

Sicherungsunterteil  
Fuse-base

**36 x 250 mm**

Verpackungseinheit / Packing unit: 1 Stück / 1 pieces

Bemessungs- spannung	Artikel Nr.	Größe	Gewicht	Bemessungs- strom	Max. Leistungsauf- nahme	Anschluß- bolzen	Max. Anzugs- drehmoment (Anschluß- bolzen)	Max. Anzugs- drehmoment (Unterteil)	Kontaktplatte
Rated Voltage	Article No	Size	Weight	Rated Current	Rated Power Acceptance	Connection bolts	Max. Nut Torque	Max. Fuse base Torque	Contact plate
V		mm	kg / 1	A	W		Nm	Nm	
DC 2000	91 096 01	36 x 250	1,028	40		M 8	22	20	Kupfer, versilbert copper, silver plated

